



Mission Statement.

“Leading the industry, Kirk Marketing is dedicated to building a sustainable visual brand, that generates prosperity for all its stakeholders. This is achieved through commitment to our products, clients and staff, with uncompromising integrity, based on our **Magnificent Seven differentiators.**”

Magnificent Seven - Differentiators.

1. 90% success rate in specification. We maintain this by promoting our unique Kirk Product Library File through targeted advertising campaigns, on line specification platforms, our in-house quoting system and the unrivalled expertise of our sales team.

2. Brand leadership. Four out of our ten brands are already market leaders and we have plans to ensure the remaining six will soon follow.

3. Market coverage. We have established a loyal customer base throughout South Africa which we serve from our four Kirk branches. In the rest of Africa we operate through our growing network of Kirk Distributors.

4. Our own Manufacturing and strong Supplier Partnerships. This allows us to create unique products and significantly improve our flexibility and competitiveness, while offering strong potential for growth.

5. Unique IT platform. Our proprietary IT system, which contains a database that has been developed over 20 years, is a powerful differentiator and driver of worldwide growth.

6. Effective Management. Our management systems allow for delegated decision making, improving response times from a well-trained Management Team that is fully aligned with our purpose and mission, ensuring longevity and passion in our company.

7. Our People - the heart of our family business. With a Profit-Sharing Scheme, training programmes incorporated into the company's daily life and the Kirk Trust focused on creating new employment, we continuously demonstrate that it is our people who make the difference.



COMMITTED TO
CLASS LEADING
EXCELLENCE



MTRIM CATALOGUE

The Kirk Marketing design team has been working together since 2002 in the tile trim industry. Using this valuable training and tremendous product knowledge, they have developed the superior and acutely functional MTrim collection.

The MTrim range of trims used for tile, carpet, vinyl, wood/laminate flooring and walls was initially developed for South African requirements, however our marketplace has expanded world wide and so have our products. Every MTrim product has been carefully and professionally designed and manufactured to international standards.

The MTrim range incorporates the most popular trims used in the flooring, walls DIY, construction and tiling industries. Our experience includes interaction with architects, designers, contractors, fitters, developers, engineers, quantity surveyors, interior designers and international trade shows. The majority of the MTrim range is available in CAD Drawings for specifications.

Our range is divided into eight sections in the product catalogue; PVC, Aluminium, Brass, Stainless Steel, Movement Joints and Structural Movement Joints, Structural Movement Joint Covers, Sections and Kirk Decor. This easy to use catalogue includes product codes, pictures of installed products and general information on specific merchandise. Further information is available on request.

Spec Builder is our online specifying platform found on our website. It allows you to write your own specifications, save them and keep them in your specification library.

BIM4U - Kirk Marketing now has its very own BIM licence. This gives one the ability to drag and drop specifications, drawings and product images directly into your design. Furthermore, you can now communicate LIVE in BIM with Kirk regarding and questions you might have about our products.

The majority of MTrim products are manufactured in South Africa.

The MTrim range of products is sold through retail outlets, displayed on Mtrim stands. Many different stands and POS are available to help you sell our MTrim products.

Retailers may choose the stand best suited to their store requirements

CONTENTS

04	Aluminium Edge Trims
11	Aluminium Stairnosings
16	Aluminium Covers
17	Aluminium Ramps
18	Aluminium Laminate Trims.
20	Aluminium Foiled Trims
21	Aluminium Carpet Trims
23	Aluminium LVT Trims
24	Kirk Decor
28	Brass Trims
32	Stainless Steel Trims
38	Movement/Structural Movement Joints
43	Structural Movement Joint Covers
46	PVC Trims
49	Aluminium Sections
51	Display Stands
54	Technical Specifications



ALUMINIUM EDGE TRIMS

All Aluminum Trims are available in 2.5m lengths unless otherwise specified.



ANODISED COLOUR CHART

Anodizing is a surface finish option on aluminium profiles. Kirk Marketing anodizes all profiles to between 5 and 15 microns. 5 Micron is suitable for bright/polished colours to ensure the brightest finish. When profiles are to be used externally, Kirk Marketing recommends that only lighter colours should be used because darker colours will fade over time, especially Black. Anodizing is a good surface finish choice for external areas as they will resist oxidation for much longer than mill finish aluminium, which can suffer from white rust in these areas. The anodized surface finish prolongs the life cycle of aluminium which is an important environmental consideration

Anodizing hardens the surface of the aluminium profile making it more scratch resistant and durable. The addition of a various range of colours gives the aluminium profile additional aesthetic qualities. Anodizing is much more durable than paint or powder coated finishes and should be the only option where foot traffic is expected. The anodised surface is not a coating that can chip or crack but rather integrated into the profile itself.

It is not recommended to form or bend anodised profiles, this action can cause crazing in the hard aluminium oxide layer which is unsightly.

The finished face of the profile must be protected against building materials like cement adhesive, grout and muriatic cleaners. These products can irreparably damage surface finishes and must be removed immediately.

Anodizing is an electro chemical process that gives a variety of colours (as shown in the chart above). Colour consistency is a drawback with this surface finish as there are so many factors involved in the process. Factors that can affect the colour consistency include; the chemical composition of the alloy – if there are slight changes in the constituents of the alloy this will affect the colour, if there are slight changes in the temper of the material it will affect the colour, if the chemistry in the anodizing tank is not consistent it can affect the colour between batches and shape geometry can also affect the colour. Colour shift of 2 to 3 shades must be accepted when ordering anodised colours and profiles need to be matched on site and used in common areas. It is better to order profiles for projects from one batch to ensure a better chance of colour consistency. It is impossible to guarantee exact colours between profiles especially from different batches and all profiles should be ordered at once.

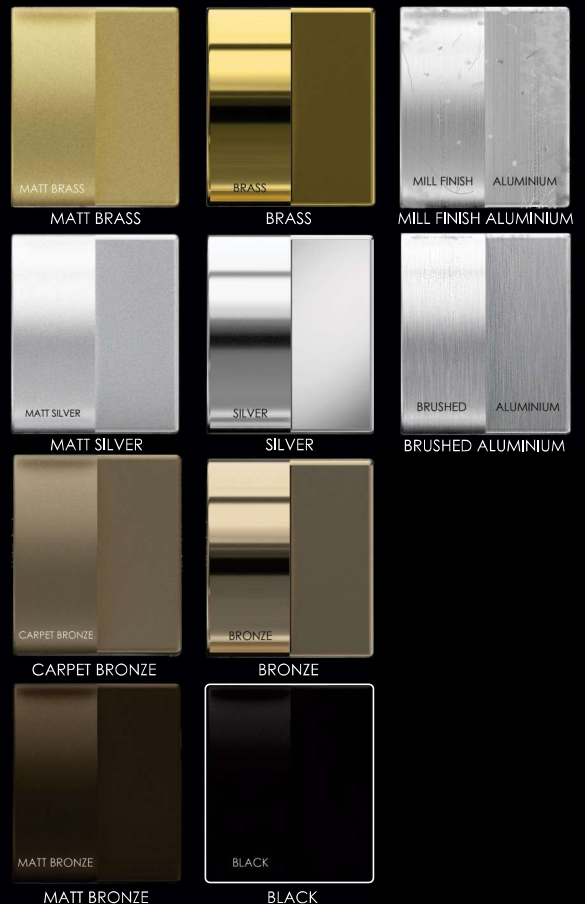

Please note that colour representation in this catalogue is an **approximation** and is as close as the printing process allows. Kirk Marketing does not in any way guarantee that the colours in this catalogue are an exact match to the finished product.

Kirk Marketing reserves the right in its absolute discretion to vary any specification or design, and to supply products which are in our sole opinion equivalent to those being offered to the purchaser.

ALUMINIUM POWDER COATED TRIMS

All Powder Coated Trims are available in 2.5m lengths unless otherwise specified.

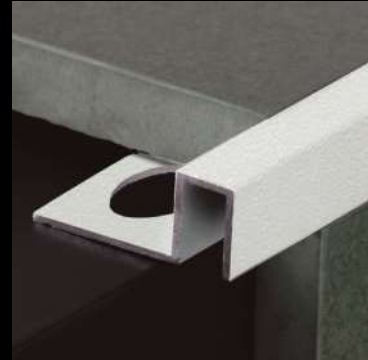

POWDERCOAT COLOUR CHART

Powder coating is a popular finish for architectural products. This surface finish has many benefits; it is a dry powder system and therefore there is no need for solvents (which emit volatile organic compounds) this makes it a good choice when environmental considerations are important, there is good colour consistency from batch to batch, powder coating forms a skin on the surface of the material which helps hide surface blemishes and die lines, powder coating is harder than a painted finish and is thus more durable.

There are also some limitations to consider; powder coating forms a skin on the surface of the material and for this reason profiles cannot be formed after coating, powder coating is a durable surface finish but can only handle very light foot traffic in domestic applications, Kirk Marketing does not recommend powder coated finishes in areas where foot traffic is expected. Debris in footwear can cause scratching, chipping and other abrasive damage to surfaces. It is an excellent choice for use on walls and other areas with little to no foot traffic.

As with all architectural finishes it is important to protect surface finishes from strong alkaline and acid building materials like cement adhesive, grout and muriatic cleaners. If the finished face of profiles do come into contact with these materials, they must be removed immediately with fresh water, it is better to tape the finished face to protect it.

Paint, powder coating, anodizing and other surface finishes used in exposed external applications can be expected to fade over time due to UV exposure and weathering.



MATT WHITE

MATT WHITE



WHITE

WHITE

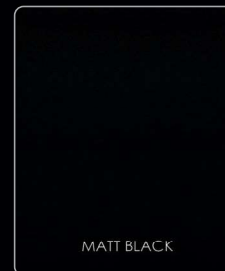

MATT BLACK

MATT BLACK



BLACK

BLACK



CONTRACTORS ALUMINIUM STRAIGHT EDGE TRIM

CODE	SIZE (d)	DESCRIPTION
CASE060	6mm	Aluminium Contractors Straight Edge Trim (3-5mm thick tile)
CASE080	8mm	Aluminium Contractors Straight Edge Trim (6-7mm thick tile)
CASE100	10mm	Aluminium Contractors Straight Edge Trim (8-9mm thick tile)
CASE120	12mm	Aluminium Contractors Straight Edge Trim (10-11mm thick tile)

The M-Trim Aluminium Contractors Straight Edge Trim is a budget profile for use in areas where there is very little to no foot traffic. This profile is not suitable for use on step edges due to the thinner wall thickness. This profile is suitable for all wall applications and external corner protection. The profile has a 2,5mm sightline as opposed to the 3mm sightline with the ASE version. The Contractors Straight Edge is supplied in 2,5m lengths.

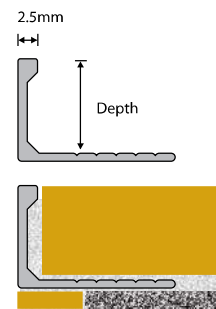

ALUMINIUM STRAIGHT EDGE TRIM

CODE	SIZE (Depth)	DESCRIPTION
ASE030	3mm	Aluminium Straight Edge Trim (2-3mm vinyl/screed)
ASE050	5mm	Aluminium Straight Edge Trim (4mm carpet/screed)
ASE060	6mm	Aluminium Straight Edge Trim (5mm carpet/screed)

M-Trim Aluminium Straight Edge Trim 3mm, 5mm and 6mm is used to protect the edge of carpets, vinyls or screeds. If you get 5mm tiles, the 6mm aluminium straight edge can be used. Available in certain anodised colours. Not all anodised colours are kept in stock, however on special order all anodised colours can be ordered with an expected lead time.

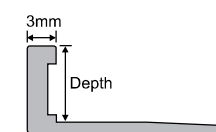
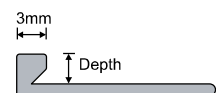

CODE	SIZE (Depth)	DESCRIPTION
ASE080	8mm	Aluminium Straight Edge Trim (6-7mm thick tile)
ASE090	9mm	Aluminium Straight Edge Trim (7-8mm thick tile)
ASE100	10mm	Aluminium Straight Edge Trim (8-9mm thick tile)
ASE120	12mm	Aluminium Straight Edge Trim (10-11mm thick tile)
ASE150	15mm	Aluminium Straight Edge Trim (13-14mm thick tile)
ASE170	17mm	Aluminium Straight Edge Trim (15-16mm thick tile)
ASE225	22,5mm	Aluminium Straight Edge Trim (20-22mm thick tile)

The M-Trim Aluminium Straight Edge Trim is used to protect and decorate the edges of tiled floor and wall surfaces. It can be used with other floor materials and applications, such as carpet and wood. M-Trim Aluminium Straight edge trims are available in a range of depths and in certain anodised colours. Not all anodised colours are kept in stock, however on special order all anodised colours can be ordered with an expected lead time.

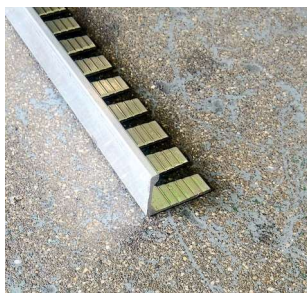

ALUMINIUM CONTRACTORS FORMABLE STRAIGHT EDGE

CODE	SIZE (Depth)	DESCRIPTION
CAFE060	6mm	Aluminium Formable Straight Edge Trim (5mm tile/6mm carpet/screed)
CAFE080	8mm	Aluminium Formable Straight Edge Trim (6-7mm thick tile)
CAFE100	10mm	Aluminium Formable Straight Edge Trim (8-9mm thick tile)
CAFE120	12mm	Aluminium Formable Straight Edge Trim (10-11mm thick tile)

M-Trim Aluminium Contractors Formable Straight Edge Trims are budget trims that can be curved and used between wall and floor tiles to protect tile edges and create interesting designs. Anodizing on formable trims is not advised.

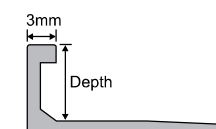

ALUMINIUM FORMABLE STRAIGHT EDGE TRIM

CODE	SIZE (Depth)	DESCRIPTION
AFE030	3mm	Aluminium Formable Straight Edge Trim (2-3mm vinyl/3mm screed)
AFE050	5mm	Aluminium Formable Straight Edge Trim (4mm vinyl/4mm screed)
AFE060	6mm	Aluminium Formable Straight Edge Trim (5mm tile/6mm carpet/screed)

M-Trim Formable Straight Edge Trims in 3mm, 5mm and 6mm are suitable for use with resilient flooring as well as carpet and mosaics. The trims can be curved and used between coverings. Anodized finishes are not recommended.

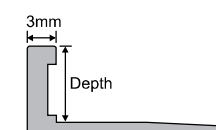
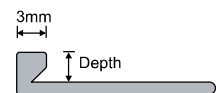

CODE	SIZE (Depth)	DESCRIPTION
AFE080	8mm	Aluminium Formable Straight Edge Trim (6-7mm thick tile)
AFE090	9mm	Aluminium Formable Straight Edge Trim (7-8mm thick tile)
AFE100	10mm	Aluminium Formable Straight Edge Trim (8-9mm thick tile)
AFE120	12mm	Aluminium Formable Straight Edge Trim (10-11mm thick tile)
AFE150	15mm	Aluminium Formable Straight Edge Trim (12-14mm thick tile)
AFE170	17mm	Aluminium Formable Straight Edge Trim (15-16mm thick tile)
AFE225	22,5mm	Aluminium Formable Straight Edge Trim (20-22mm thick tile)

The M-Trim Aluminium Formable Straight Edge Trim can be shaped into curves by using hand pressure. Once the desired form has been achieved the trim is fixed using concrete nails or screws. Available in a range of depths. Anodised colours are not advised for formable trims, however, on request we are able to anodise required lengths.



ALUMINIUM ELITE STRAIGHT EDGE TRIM (5mm Sightline)

CODE	SIZE (w/d)	DESCRIPTION
AESE100	5mm x 10mm	Aluminium Elite Straight Edge Trim (8-9mm thick tile)

M•Trim Aluminium Elite Straight Edge Trim is the same as the Aluminium Straight Edge except it has a 5mm wide top section on the trim, showing a larger aluminium edge. Available in the anodised colours. Available in certain anodised colours. Not all anodised colours are kept in stock, however on special order all anodised colours can be ordered with an expected lead time.

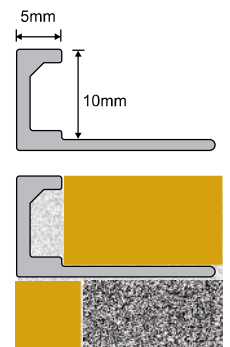

ALUMINIUM ELITE FORMABLE STRAIGHT EDGE TRIM (5mm wide)

CODE	SIZE (w/d)	DESCRIPTION
AEFE100	5mm x 10mm	Aluminium Elite Formable Straight Edge Trim (8-9mm thick tile)

M•Trim Aluminium Elite Formable Straight Edge Trim is the same as the Aluminium Formable Straight Edge except it has a 5mm wide top section on the trim, showing a larger aluminium edge. M•Trim Elite Aluminium Formable Straight Edge Trim can be shaped into curves by using hand pressure. Once the desired form has been achieved the trim is fixed using concrete nails or screws. Anodised colours are not advised for formable trims, however, on request we are able to anodise required lengths.

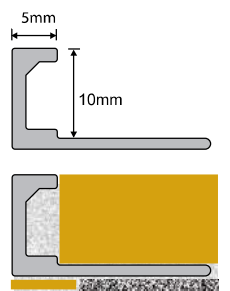

ALUMINIUM SQUARE EDGE TRIM

CODE	SIZE (w/d)	DESCRIPTION
ASQE060	6mm x 6mm	Aluminium Square Edge Trim (4mm mosaic)
ASQE080	8mm x 8mm	Aluminium Square Edge Trim (6mm mosaic)

M•Trim Aluminium Square Edge Trim corner protectors for 4mm and 6mm mosaics. Available in certain anodised colours. Not all anodised colours are kept in stock, however on special order all anodised colours can be ordered with an expected lead time.

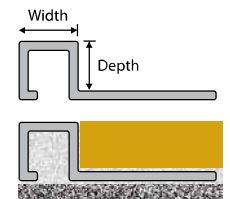

CODE	SIZE (w/d)	DESCRIPTION
ASQE100	8mm x 10mm	Aluminium Square Edge Trim (8-9mm thick tile)
ASQE120	8mm x 12mm	Aluminium Square Edge Trim (10-11mm thick tile)

M•Trim Aluminium Square Edge Trim is used to protect and decorate the edges of tiled floor and wall surfaces. The aluminium edge showing an 8mm wide top section on the trim. It can be used with other floor materials and applications, such as wood and carpet. M•Trim square edge is available in two sizes (10mm and 12mm) and in certain anodised colours. Not all anodised colours are kept in stock, however on special order all anodised colours can be ordered with an expected lead time.

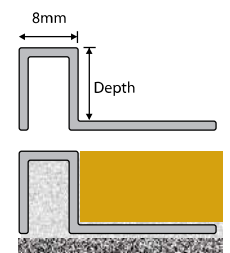

ALUMINIUM FORMABLE SQUARE EDGE TRIM

CODE	SIZE (w/d)	DESCRIPTION
AFQE060	6mm x 6mm	Aluminium Formable Square Edge Trim (4mm mosaic)
AFQE080	8mm x 8mm	Aluminium Formable Square Edge Trim (6mm mosaic)

M•Trim Aluminium Formable Square Edge Trim for 4mm and 6mm mosaics. Anodised colours are not advised for formable trims, however, on request we are able to anodise required lengths.

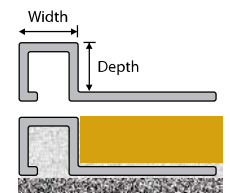

CODE	SIZE (w/d)	DESCRIPTION
AFQE100	8mm x 10mm	Aluminium Formable Square Edge Trim (8-9mm thick tile)
AFQE120	8mm x 12mm	Aluminium Formable Square Edge Trim (10-11mm thick tile)

M•Trim Aluminium Formable Square Edge Trim can be shaped into curves by using hand pressure. Once the desired form has been achieved the trim is fixed using concrete nails or screws. Anodised colours are not advised for formable trims, however, on request we are able to anodise required lengths. The aluminium edge showing is 8mm wide top section on the trim. It can be used with other floor materials and applications, such as wood and carpet. M•Trim formable square edge is available in 6mm, 8mm 10mm and 12mm. Can be formed using Z-Flex Curver.

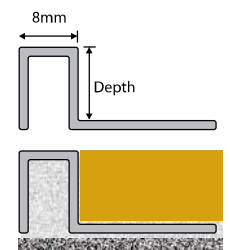

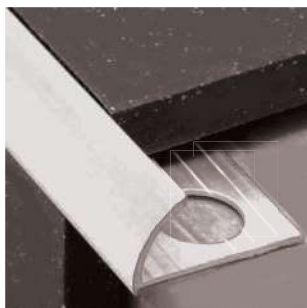

CONTRACTORS ALUMINIUM ROUND EDGE TRIM

CODE	SIZE (Depth)	DESCRIPTION
CARE100	10mm	Aluminium Round Edge Trim (8-9mm thick tile)
CARE120	12mm	Aluminium Round Edge Trim (10-11mm thick tile)

CARE100 and CARE120 are contractors round edge trims for budget projects or where the level of traffic is low with little to no risk of constant contact with tiled wall edges. The CARE profiles have a thinner wall thickness and can only be used on walls.

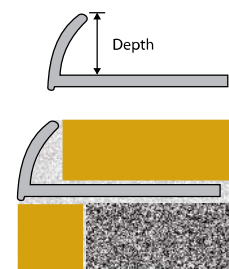

ALUMINIUM ROUND EDGE TRIM

CODE	SIZE (Depth)	DESCRIPTION
ARE080	8mm	Aluminium Round Edge Trim (6-7mm thick tile)
ARE100	10mm	Aluminium Round Edge Trim (8-9mm thick tile)
ARE120	12mm	Aluminium Round Edge Trim (10-11mm thick tile)

The M•Trim Aluminium Round Edge Trim has a semi-round face that offers an aesthetic finish to tile edges. It is used for decorative purposes and for tile edge protection. Not recommended for floors. This M•Trim is available in a variety of depths and in certain anodised colours. Not all anodised colours are kept in stock, however on special order all anodised colours can be ordered with an expected lead time.

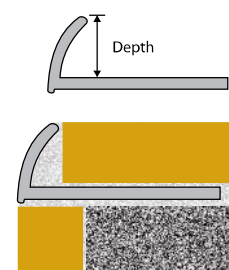

ALUMINIUM QUADRANT EDGE TRIM

CODE	SIZE (Depth)	DESCRIPTION
AQE090	9mm	Aluminium Quadrant Edge Trim (7-8mm thick tile)
AQE100	10mm	Aluminium Quadrant Edge Trim (8-9mm thick tile)
AQE120	12mm	Aluminium Quadrant Edge Trim (10-11mm thick tile)

The M•Trim Aluminium Quadrant Edge Trim offers more face than the M•Trim Aluminium Round Edge Trim to finish off tile edges. It is used for decorative purposes and for tile edge protection. If used on floors, pack quadrant with tile adhesive to add strength. This M•Trim is available in a variety of depths and in certain anodised colours. Not all anodised colours are kept in stock, however on special order all anodised colours can be ordered with an expected lead time.

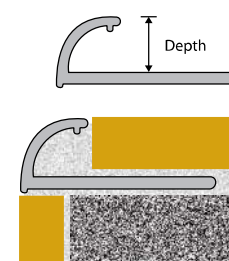

ALUMINIUM TILE-IN CORNER PROTECTOR

CODE	SIZE (w/d)	DESCRIPTION
ATICP100	30mm x 10mm	Aluminium Tile-in Corner Protector (8-9mm thick tile)
ATICP120	30mm x 12mm	Aluminium Tile-in Corner Protector (10-11mm thick tiles.)

M•Trim Aluminium Tile-in Corner Protector is fitted on walls and columns. The size of the corner protector is 30mm x 30mm. It protects external corners of walls and columns against trolleys and general wear and tear. The Aluminium Tile-in corner protector is used for decorative purposes as well as protection. It is available in certain anodised colours. Not all anodised colours are kept in stock, however on special order all anodised colours can be ordered with an expected lead time. Also available in stainless steel.

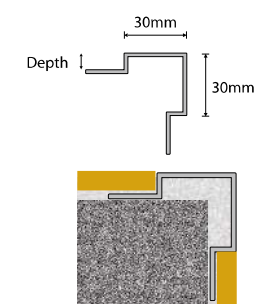

ALUMINIUM RETRO-FIT CORNER PROTECTORS (3m Lengths)

CODE	SIZE (w/w/t)	DESCRIPTION
ACP127	12.7mm x 12,7mm x 1.6mm	Aluminium Retro-fit Corner Protector
ACP250	25mm x 25mm x 1.3mm	Aluminium Retro-fit Corner Protector
ACP380	38mm x 38mm x 2mm	Aluminium Retro-fit Corner Protector
ACP502	50mm x 50mm x 2mm	Aluminium Retro-fit Corner Protector

M•Trim Aluminium Retro-fit Corner Protector is available in different thicknesses and sizes and is retrospectively fixed using appropriate adhesives. It is used to provide protection on external corners after main wall covering or finish has been installed. Especially useful in renovations where damage has already occurred and the corner protector is then used to cover the damage at minimal cost. The M•Trim Aluminium Retro-fit Corner Protector provides an aesthetically pleasing alternative to major renovations. Available in certain anodised colours. Not all anodised colours are kept in stock, however on special order all anodised colours can be ordered with an expected lead time. M•Trim PVC, Brass, Stainless Steel corner protectors are also available, please refer to appropriate category.

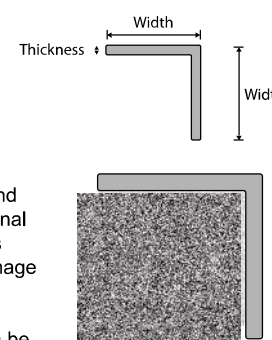



ALUMINIUM TILE-IN CORNER BEADING

CODE	SIZE (w/d)	DESCRIPTION
ATICB100	10mm x 10mm	Aluminium Tile-In Corner Beading (8-9mm thick tiles)
ATICB120	12mm x 12mm	Aluminium Tile-In Corner Beading (10-11mm thick tiles.)

The M•Trim Aluminium Tile-In Corner Beading is used on columns to protect the biscuit of the tile and for aesthetic reasons on the corner of the columns. Available in certain anodised colours. Not all anodised colours are kept in stock, however on special order all anodised colours can be ordered with an expected lead time.

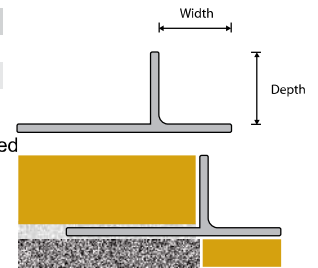

ALUMINIUM TILE-IN LISTELLO

CODE	SIZE (w/d)	DESCRIPTION
ALI100	10mm x 10mm	Aluminium Listello for wall tiles (8-9mm thick tile)
ALI200	20mm x 10mm	Aluminium Listello for wall tiles (8-9mm thick tile)

M•Trim Aluminium Listello available in two sizes 10mm and 20mm wide section assists in creating a decorative effect within tiled wall coverings. The listellos are installed during tiling. The 10mm wide aluminium listello can be used as a tile divider on the floor. Available in certain anodised colours. Not all anodised colours are kept in stock, however on special order all anodised colours can be ordered with an expected lead time. Also available in stainless steel.

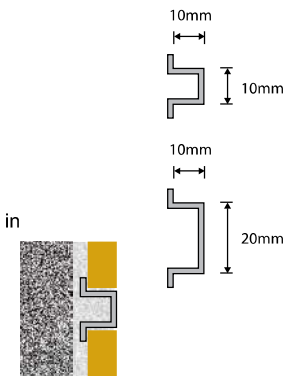

ALUMINIUM PENCIL LISTELLO

CODE	SIZE (w/d)	DESCRIPTION
APLI100	10mm x 8mm	Aluminium Pencil Listello for all thickness tiles
APLI200	20mm x 8mm	Aluminium Pencil Listello for all thickness tiles

M•Trim Pencil Listello is available in 10mm and 20mm widths and can be used with tiles from 8mm thick and up. The M•Trim Pencil listello is embedded in the tile adhesive for thicker tiles, allowing the 10mm width to finish flush with edge of the tile surface. Stainless steel versions are also available.

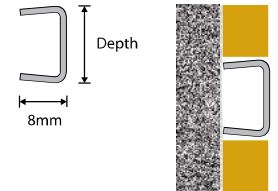

ALUMINIUM DOMED CAPPING STRIP

CODE	SIZE (d/w)	DESCRIPTION
ADCS100	8mm x 10mm	Aluminium domed capping strip

M•Trim Aluminium Domed Capping Strip is a versatile profile for use with wall tiling, junctions between counters and walls and in frameless shower applications. The Domed Capping Strip is installed after tiling and is installed using tile grout or a flexible adhesive. Use the profile as a water retention strip with frameless shower panels, the Domed Capping Strip will retain most of the water in the shower area and the dome still remains comfortable under foot. The profile can also be used as a 3D listello in wall tiling to add depth and an interesting décor finish. When finishing off the gap or internal corner where counter tops meet wall tiles, the Domed Capping Strip gives a neat and hygienic finish when used with an appropriate flexible adhesive. The Domed Capping Strip is supplied in 2,5m lengths in various anodized finishes, other finishes are available on special order with a lead time.

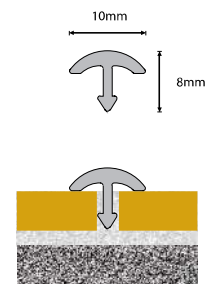

ALUMINIUM U-CHANNEL (3m Length)

CODE	SIZE (d/w)	DESCRIPTION
AUC952	9.52mm x 9.52mm	Aluminium U-Channel - shadow line listello (7-8.5mm tile)
AUC127	12.7mm x 12.7mm	Aluminium U-Channel - shadow line listello (9-11.5mm tile)

The M•Trim U-Channel is used as a shadow line listello to break up plain wall tiles and its main function is aesthetics. Both Aluminium U-channel's can be embedded in tile adhesive when using thicker tiles. You can choose your width of the shadow line. Available in certain anodised colours. Not all anodised colours are kept in stock, however on special order all anodised colours can be ordered with an expected lead time.

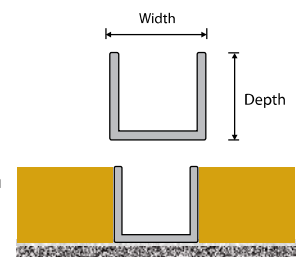

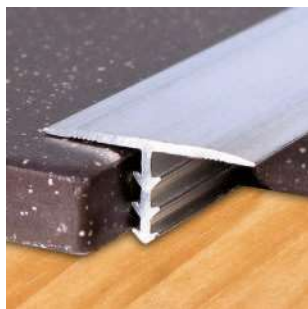

23mm ALUMINIUM CAPPING STRIP (Dividing Strip) + Base

CODE	SIZE (w/d)	DESCRIPTION
ACS230	23mm x 10mm	Aluminium Capping Strip (Tile Divider)

The M•Trim Aluminium Capping Strip can be used as a capping strip or as a dividing strip between different tiled surfaces or between tiled and wooden floors, protecting the different floor surfaces. It can either be fixed during or after tiling. Using the appropriate flexible adhesive, the aluminium capping strip can also act as a movement joint. Available in certain anodised colours. Not all anodised colours are kept in stock, however on special order all anodised colours can be ordered with an expected lead time. The aluminium capping strip is also formable creating curves with a Z-flex curver, allowing designers freedom to design curves in their floor layouts. Also available in brass.

CODE	SIZE (w/d)	DESCRIPTION
ATB100T	10mm	Aluminium Capping Strip Base - Straight
ATB100F	10mm	Aluminium Capping Strip Base - Formable

The M•Trim Capping Strip fits into the Aluminium carpet to tile base, both the straight and formable version thereof.

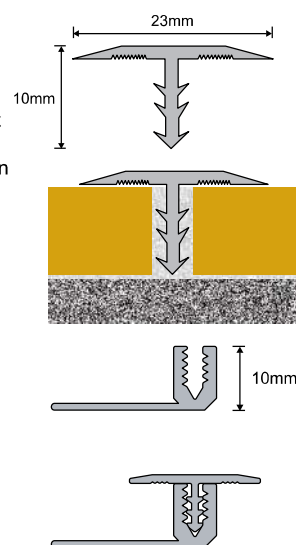

30mm ALUMINIUM CAPPING STRIP (Dividing Strip) + Base

2.7m length

CODE	SIZE (width)	DESCRIPTION
ACS300	30mm	Aluminium Capping Strip (tile divider)

M•Trim Aluminium Capping Strip with a 30mm wide cover can be used as a dividing strip between same level flooring types, protecting the edges of the different floor surfaces as well as acting as a movement joint cover allowing for the movement in laminate/ wood floors. The extra width of the capping strip allows for larger movement sometimes experienced in the wood/laminate flooring. Available in certain anodised colours. Not all anodised colours are kept in stock, however on special order all anodised colours can be ordered with an expected lead time.

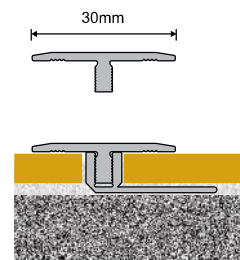

ALUMINIUM CAPPING STRIP BASE

2.7m length

CODE	SIZE (depth)	DESCRIPTION
ACB080	8mm	Aluminium Cover Base
ACB100	10mm	Aluminium Cover Base
ACB140	14mm	Aluminium Cover Base

M•Trim Aluminium Cover Base is used as the base to fit the 30mm aluminium capping strip (above). The aluminium cover base allows for different thickness floors from 7mm to 16mm.

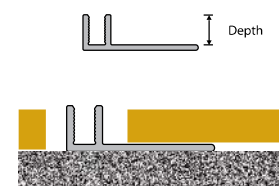

ALUMINIUM FLAT BAR

3m length

CODE	SIZE (w/d)	DESCRIPTION
AFB250	25mm	Aluminium Flat Bar
AFB380	38mm	Aluminium Flat Bar
AFB500	50mm	Aluminium Flat Bar

M•Trim Aluminium Flat Bar is used as a dividing strip fitted as a Retro-fit or tiled in with the screed and tile. Can be used in matwells. The Flat bar is available in 3mm thickness and different depths. Available in certain anodised colours. Not all anodised colours are kept in stock, however on special order all anodised colours can be ordered with an expected lead time. Other sizes of flat bar available on special order with minimum order quantities.

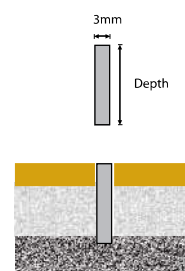

ALUMINIUM

STAIR-NOSINGS COLOUR CHART

STAIRNOSING PVC INSERTS COLOURS



CARBORUNDUM COLOURS

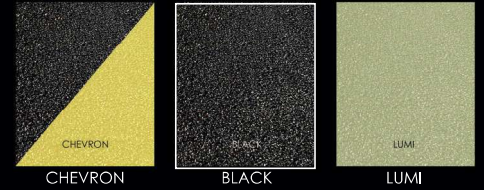

Please note that the colour representation in this catalogue is an approximation and is as close as the printing process will allow. Kirk Marketing does not in any way guarantee that the colours in this catalogue are an exact match to the finished product. Kirk Marketing reserves the right in its absolute discretion to vary any specification or design, and to supply products which are in our sole opinion, equivalent to those being offered to the purchaser.

STAIRNOSING NONSLIP INSERTS COLOURS



DIAMOND RUBBER INSERTS

2,5m lengths unless otherwise specified.

The self-adhesive Diamond Rubber inserts are available in 2,5m and 10m rolls. The rubber pyramid/diamond design gives excellent anti-slip protection in wet and dry conditions. This insert is suitable for internal and external areas, but not in direct sunlight as this can affect the adhesive.



NON-SLIP INSERTS

2,45m lengths unless otherwise specified.

The Non-Slip inserts are patented non-slip inserts constructed with fine Silicone Carbide and Space Age Resins onto a hardy flexible substrate. The Non-Slip strips substrate is ABS Plastic, a plastic with high impact resistance, suitable for heavy duty applications.

Available in 2 colours : Black and Grey. Expected lifespan is more than 3 years. The inserts are easy to replace and are all weather inserts. The inserts have excellent slip resistant qualities in adverse conditions – Oil, grease, Dust, Liquids, Powder and Fat. The non-slip inserts are inserted into the different types of Stairnosings and glued with a recommended adhesive.



LUMINESCENCE NON-SLIP INSERTS

2,45m lengths unless otherwise specified.

The Luminescence strip is embedded in epoxies and is slightly lower than the non-slip silicone carbide ensuring it is protected from wear and tear. The Luminescence strip lasts for 12 hours maximum, which is more than the 5 hours required by SABS. Ideal for badly lit or dark stair wells. Can be used in cinemas, theatres and poorly lit public areas. Luminescence strips need to be stimulated by a light source to get its luminescence.

The Luminescence Strips are photo luminescent vinyl (NAV720) made by alkaline-earth aluminate and silicate which are activated by rare earth elements. Its features include high luminance, long lasting luminance and weather-proof. The Luminescence strip is non-toxic, non-radioactive and has stable chemical properties.

Under a light source of 1000LX for 15minutes, you get 12hours of Luminescence from the NAV720 luminescent vinyl. The SABS norm required is 5 hours.

A degree of normal 25LX brightness can be a source of stimulating light. Inside a building, the normal light can reach 500-600LX. Therefore, sunshine as well as normal light can be used as sources of stimulating light.



ALUMINIUM TILE-IN STAIR-NOSING

CODE	SIZE (w/d)	DESCRIPTION
ATIN100	25mm x 10mm	Aluminium Tile-In Stair-nosing (8-9mm thick tile)
ATIN120	25mm x 12mm	Aluminium Tile-In Stair-nosing (10-11mm thick tile)

This M•Trim Aluminium Tile-In Stair-nosing is installed during tiling and acts as an excellent tile-in stair-nosing for domestic and commercial use.

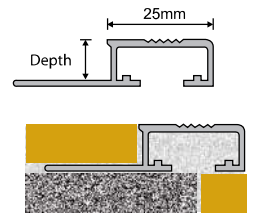

FOR RETRO-FIT STAIR-NOSING WITH INFILL, CHECK THE LATEST PRICE LIST FOR DETAILS ON INDIVIDUAL PARTS AND COMBINED CODES.

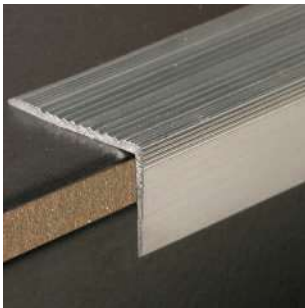

ALUMINIUM RETRO-FIT STAIR-NOSING

CODE	SIZE (w/d)	DESCRIPTION
ARN300	30mm x 20mm	Aluminium Retro-fit Stair-nosing for all stair types
ARN460	46mm x 27mm	Aluminium Retro-fit Stair-nosing for all stair types

The M•Trim Aluminium Retro-fit Stair-nosing is used on existing tiled stairs to protect the stair tiles from breaking and chipping. It can also be used to cover areas where damage has already occurred. The M•Trim Retro-fit Stair-nosing can be fixed onto a wide variety of stair materials. This M•Trim Stair-nosing is slip resistant and highly visible, reducing the possibilities of accidents. Depending on the stair material (e.g. tile, carpet, wood, vinyl) various recommended adhesives are used to affix the stair-nosing. Available in certain anodised colours. Not all anodised colours are kept in stock, however on special order all anodised colours can be ordered with an expected lead time.

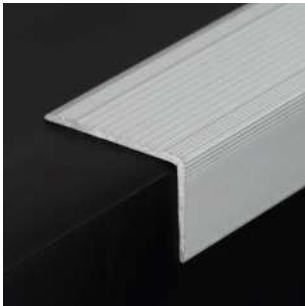
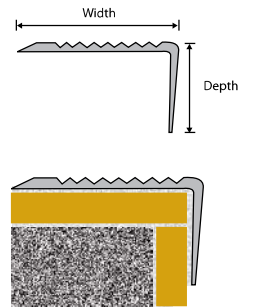

ALUMINIUM RETRO-FIT STAIR-NOSING WITH PVC INSERT OR DIAMOND RUBBER

CODE	SIZE (Depth)	DESCRIPTION
APRN620	62mm x 30mm	Aluminium Retro-fit Stair-nosing base

The M•Trim Retro-fit Stair-nosing with smooth PVC or Diamond Rubber insert. It is used on various stair materials and is affixed using appropriate adhesives and/or screws and plugs. Choice of PVC inserts are Grey or Black.

INSERT CHOICE

CODE	SIZE (Depth)	DESCRIPTION
APRN44S	44mm x 2mm	44mm Smooth PVC Insert
DR144.08	44mm X 3mm	44mm Diamond Rubber Insert

The M•Trim 44mm Smooth PVC Insert is available in Grey or Black. The insert must be glued into the base using appropriate adhesives and can be replaced when needed. Other colours are available with a minimum order of 500m. The Diamond Rubber insert is available in black only. The insert is suitable for internal and external applications except in direct sunlight.

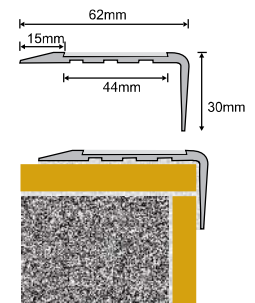



ALUMINIUM RETRO-FIT STAIR-NOSING WITH CARBORUNDUM INSERTS

BASE

CODE	SIZE (w/d)	DESCRIPTION
ARCN450	45mm x 28mm	Aluminium Retro-fit Stair-nosing base

The Aluminium Retro-fit Stair-nosing with Carborundum Insert is used on existing flooring to protect the stair edge from damage and wear and tear. It is affixed using appropriate adhesives and/or screws and plugs. Anodised colours available on request. Choice of Carborundum insert colours.

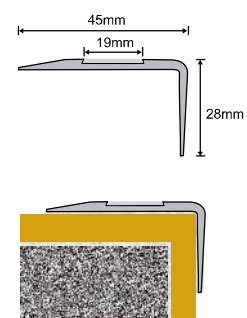

INSERT CHOICE

CODE	SIZE (w/d)	DESCRIPTION
ARCN450,08 (INF)	19mm x 1mm	19mm Carborundum Insert - Black
ARCN450,31 (INF)	19mm x 1mm	19mm Carborundum Insert - Luminescent

The self adhesive Carborundum insert is available in black and luminescent. The Carborundum insert provides an effective anti-slip feature for low to medium foot traffic in internal and external areas. The insert can be replaced when needed.

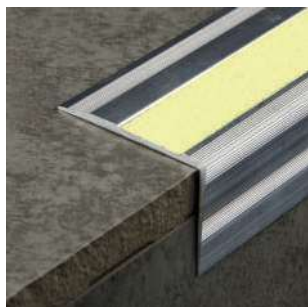

ALUMINIUM DOUBLE RETRO-FIT STAIR-NOSING with CHOICE OF INSERTS

BASE

CODE	SIZE (w/d)	DESCRIPTION
APDRN850	85mm x 30mm	Aluminium Double Retro-fit Stair nosing base

The M•Trim Aluminium Double Stair-nosing with PVC/Non Slip Inserts is used on various floor materials in heavy duty applications to protect the stair edge from damage and wear and tear. The wide tread with two inserts provides an effective anti-slip feature in high traffic areas. Choose the correct combination of Inserts for the application. The Double Stair-nosing is affixed using appropriate adhesives and/or screws and plugs.

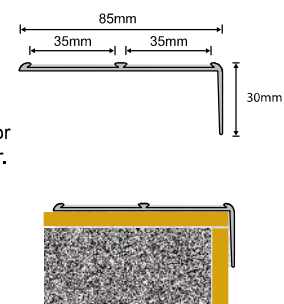

INSERT CHOICE

CODE	SIZE (w/d)	DESCRIPTION
APRN37S	35mm x 2mm	Smooth PVC Insert
APRN37R	35mm x 2mm	Ridged PVC Insert
ANSRN37	35mm x 2mm	Non Slip Insert
ALNSRN37	35mm x 2mm	Luminescent Non Slip Insert
DRI35,08	35mm x 2mm	Diamond Rubber Insert - Black

There is a choice of Insert for use in the M•Trim Aluminium Double Retro-fit Stair-nosing. The PVC Insert is available in a smooth and ridged version and both provide an effective anti-slip feature for internal use. The ridged version can be used externally if needed. The PVC Insert is available in Brown, Black and Grey. The PVC Insert must be glued to the Stair-nosing using appropriate adhesives. Other colours are available on special order with a minimum of 500m. Remember to order two inserts per base.

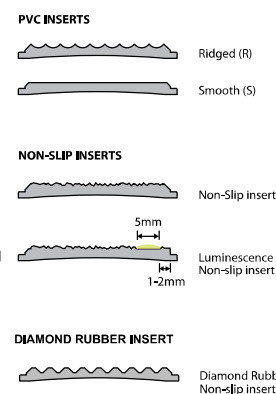

The Non Slip Inserts are available in a plain and Luminescent version in Black and Grey. Any combination of Non Slip Inserts can be used (Plain + Lumi, Plain + Plain, Lumi + Lumi) for the application. The Non Slip Inserts are designed to give a superior Anti Slip feature in internal and external areas. The Luminescent Non Slip Insert gives added safety by indicating the step edge in dark areas like stairwells, external stairs and theatres. The Non Slip Inserts must be glued into the Stair-nosing using appropriate adhesives and can be replaced when needed. Remember to order two inserts per base.

Diamond Rubber Infill is suitable for internal and external applications, except in direct sunlight. The rubber with pyramid design gives excellent anti-slip properties. The infill is self adhesive and very easy to install into the base.

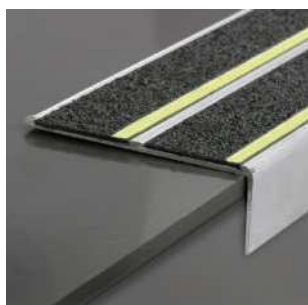

ALUMINIUM RETRO-FIT STAIR-NOSING with CHOICE OF INSERTS

BASE

CODE	SIZE (w/d)	DESCRIPTION
APRN450	45mm x 30mm	Aluminium Retro-fit Stair nosing
APRN45040	45mm x 40mm	Aluminium Retro-fit Stair nosing

The M•Trim Aluminium Retro-fit Stair-nosing with PVC/Non Slip Inserts is used on various floor materials in low to medium duty applications to protect the stair edge from damage and wear and tear. Anodised colours available on request. The Stair-nosing is affixed using appropriate adhesives and/or screws and plugs. Choose the Insert to suit the application. APRN45040 base complies with SANS10400.

INSERT CHOICE

CODE	SIZE (w/d)	DESCRIPTION
APRN37S	35mm x 2mm	Smooth PVC Insert
APRN37R	35mm x 2mm	Ridged PVC Insert
ANSRN37	35mm x 2mm	Non Slip Insert
ALNSRN37	35mm x 2mm	Luminescent Non Slip Insert
DRI35.08	35mm x 2mm	Diamond Rubber Insert - Black

There is a choice of Insert for use in the M•Trim Aluminium Retro-fit Stair-nosing. The PVC Insert is available in a smooth and ridged version and both provide an effective anti-slip feature for internal use. The ridged version can be used externally if needed. The PVC Insert is available in Brown, Black and Grey. The PVC Insert must be glued to the Stair-nosing using appropriate adhesives. Other colours are available on special order with a minimum of 500m.

The Non Slip Inserts are available in a plain and Luminescent version in Black and Grey. The Non Slip Inserts are designed to give a superior Anti Slip feature in internal and external areas. The Luminescent Non Slip Insert gives added safety by indicating the step edge in dark areas like stairwells, external stairs and theatres. The Non Slip Inserts must be glued into the Stair-nosing using appropriate adhesives and can be replaced when needed.

Diamond Rubber Infill is suitable for internal and external applications, except in direct sunlight. The rubber with pyramid design gives excellent anti-slip properties. The infill is self adhesive and very easy to install into the base.

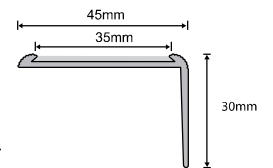

PVC INSERTS

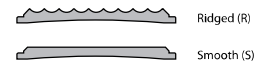

NON-SLIP INSERTS

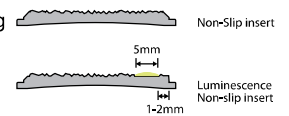

DIAMOND RUBBER INSERT

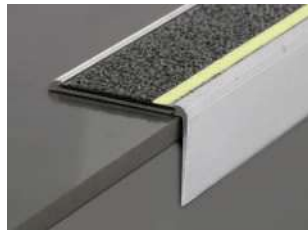

ALUMINIUM RETRO-FIT BULL-NOSING with CHOICE OF INSERTS

BASE

CODE	SIZE (w/d)	DESCRIPTION
APRBN520	52mm x 30mm	Aluminium Retro-fit Bull-nosing

The M•Trim Aluminium Bull-nosing with PVC/Non Slip Inserts is used on various floor materials in low to medium duty applications to protect stair edges from damage and wear and tear. The bull nose design gives an appealing aesthetic finish. Anodised colours are available on request. The Stair-nosing is affixed using appropriate adhesives and/or screws and plugs. Choose the Insert to suit the application.

INSERT CHOICE

CODE	SIZE (w/d)	DESCRIPTION
APRN37S	35mm x 2mm	Smooth PVC Insert
APRN37R	35mm x 2mm	Ridged PVC Insert
ANSRN37	35mm x 2mm	Non Slip Insert
ALNSRN37	35mm x 2mm	Luminescent Non Slip Insert
DRI35.08	35mm x 2mm	Diamond Rubber Insert - Black

There is a choice of Insert for use in the M•Trim Aluminium Retro-fit Bull-nosing. The PVC Insert is available in a smooth and ridged version and both provide an effective anti-slip feature for internal use. The ridged version can be used externally if needed. The PVC Insert is available in Brown, Black and Grey. The PVC Insert must be glued to the Stair-nosing using appropriate adhesives. Other colours are available on special order with a minimum of 500m.

The Non Slip Inserts are available in a plain and Luminescent version in Black and Grey. The Non Slip Inserts are designed to give a superior Anti Slip feature in internal and external areas. The Luminescent Non Slip Insert gives added safety by indicating the step edge in dark areas like stairwells, external stairs and theatres. The Non Slip Inserts must be glued into the Stair-nosing using appropriate adhesives and can be replaced when needed.

Diamond Rubber Infill is suitable for internal and external applications except in direct sunlight. The rubber with pyramid design gives excellent anti-slip properties. The infill is self adhesive and very easy to install into the base.

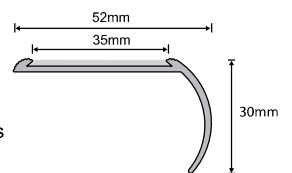

PVC INSERTS

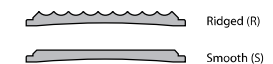

NON-SLIP INSERTS

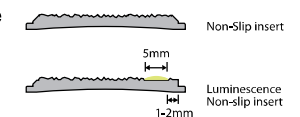

DIAMOND RUBBER INSERT



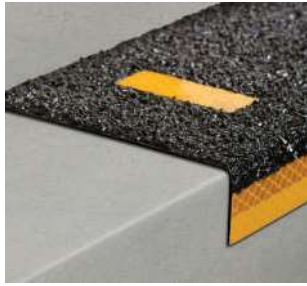

INDUSTRIAL RETROFIT NON-SLIP STAIR-NOSING

CODE	SIZE (length x width)	DESCRIPTION
INSN,GALV	variable	Industrial Retrofit Non-Slip Nosing with Galvanised base – fine, medium or coarse grit
INSN,3CR12	variable	Industrial Retrofit Non-Slip Nosing with 3CR12 metal base – fine, medium or coarse grit
INSN,304	variable	Industrial Retrofit Non-Slip Nosing with Grade 304 Stainless Steel base – fine, medium or coarse grit

Fully Integrated patented non-slip stair tread for factory and industrial applications. Constructed with Silicone Carbide and Space age Epoxies and Resins on various metal backings including galvanised steel, 3CR12 Steel plate and/or Grade 304 Stainless Steel Plate.

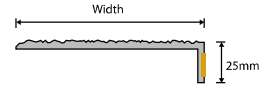

The Non-Slip Silicone Carbide material is available in fine, medium and coarse grits dependant on how much pedestrian traffic is used. We recommend fine grit for Light Pedestrian Traffic, medium grit for Medium Pedestrian Traffic and coarse grit for Heavy Pedestrian Traffic.



The Non-Slip tread is slip resistant in the most adverse conditions such as Oil, Grease, Fat, Dust, Liquids and Powder.

The Non-Slip Stair Treads are custom designed with certain dimension limitations: Length is a minimum 300mm to a maximum 2400mm. Longer length stair treads are butt jointed. Width is a minimum 50mm to a maximum 250mm. Standard Stair Lip is 25mm with the following options; a reflective strip on the riser and the reflective strips on the tread which are 40mm off the edge. The industrial nosing can also be supplied with a luminescent strip 40mm from the step edge or with no reflective tape or luminescent strip.

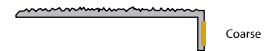

The Non-Slip Stair Treads are long-lasting, durable, chemical resistant, non static and impact resistant.



The Industrial Non-Slip Stair Treads can be fitted to Concrete, Steel and Checker plate and Mentis Grating stairwells. There is different fitting methods per substrate. Please request fitting method instructions when you encounter the different substrates. We will forward instructions with the product supplied for the different substrates.



ALUMINIUM CONTRACTORS DOUBLE RETRO-FIT NOSING WITH RIDGED PVC INFILLS

CODE	SIZE (w/d)	DESCRIPTION
ACDPRN750	75mm x 27mm	Aluminium Contractors Double Retro-Fit Nosing base.
APRN25R.(INF)	25mm	25mm PVC Insert for Contractors Retro-fit Stair-nosing

The Aluminium Contractors Double Retro-fit Stair-nosing is a contractors version where the infill simply drops into the aluminium base, no adhesive is required. This is an economical and quick solution for high traffic areas that require extra anti-slip properties. The aluminium base is glued with an appropriate adhesive and/or fixed with screws and plugs. The infill, available in black or grey, is squeezed and inserted into the base, the design holds the infill in place and it is easily removed and replaced when needed. **NOTE: Two lengths of insert are required for the Double Retro-fit Stair-nosing.** The infill can also be glued into the track using an appropriate adhesive. The base and insert are sold separately. Also available in bulk rolls for seamless installation.

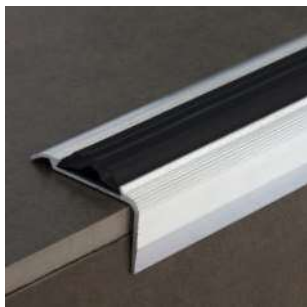
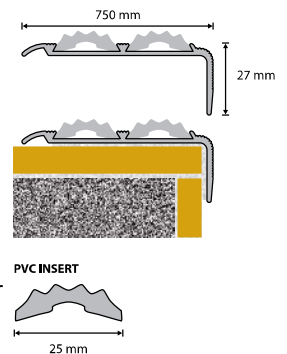

ALUMINIUM CONTRACTORS RETRO-FIT NOSING WITH RIDGED PVC INFILL

CODE	SIZE (w/d)	DESCRIPTION
ACPRN460	46mm x 28mm	Aluminium Contractors Retro-fit Stair Nosing base
APRN25R.(INF)	25mm	25mm PVC Insert for Contractors Retro-fit Stair-nosing

The Aluminium Contractors Retro-fit Stair-nosing is a contractors version where the infill simply drops into the aluminium base, no adhesive is required. This is an economical and quick solution for low to medium traffic areas that require anti-slip properties. The aluminium base is glued with an appropriate adhesive and/or fixed with screws and plugs. The infill, available in black or grey, is squeezed and inserted into the base, the design holds the infill in place and it is easily removed and replaced when needed. The infill can also be glued into the track using an appropriate adhesive. The base and insert are sold separately. Also available in bulk rolls for seamless installation.

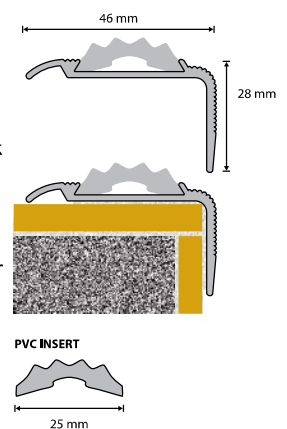

ALUMINIUM TRANSITION COVERS AND BASES

COVERS 90cm, 1m, 2.5m and 2.7m Lengths

CODE	SIZE (width)	DESCRIPTION
ATC300	30mm	Aluminium Transition Cover (30mm wide)
ATC380	38mm	Aluminium Transition Cover (38mm wide)
ATC290	29mm	Aluminium Transition Cover (29mm wide)
ATC280	28mm	Aluminium Transition Cover (28mm wide) Undrilled
ATC470	47mm	Aluminium Transition Cover (47mm wide) Undrilled

This aluminium M•Trim range of different transition base and cover trims allows the fitter various options for successfully joining different floor coverings by achieving a neat and durable finish between the floor transitions. The covers can be used without the base trims e.g. screwed on over the transition line between floor types that were not laid with the base trim. The range of M•Trim covers can also be used in doorways, between different materials, great for refurbishments. The ATC470 is 47mm wide cover made with thicker aluminium for medium to heavy traffic. The floor surface height variance can be accommodated with the ATC280 (4mm) and ATC290 (6mm). Covers are available in drilled and undrilled versions.

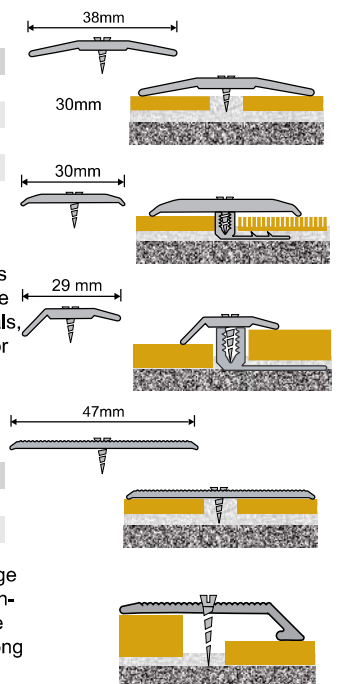

BASES

CODE	SIZE (w/d)	DESCRIPTION
ATB100T	30mm x 10mm	Aluminium Transition Base (Tile)
ATB100C	30mm x 10mm	Aluminium Transition Base (Carpet)

M•Trim Aluminium Tile to Carpet base is for floors from 10mm thick used with the full range of M•Trim carpet covers and the 23mm wide M•Trim Aluminium Capping Strip. The Aluminium Tile to Carpet base is available in both the straight and formable version, the formable version used with the curved 23mm wide M•Trim Aluminium capping strip. Use a 10mm long countersunk screw to attach the appropriate cover to the base with 10mm thick flooring.

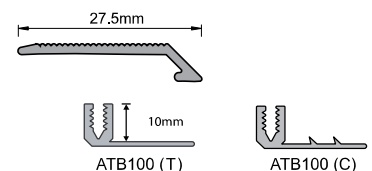

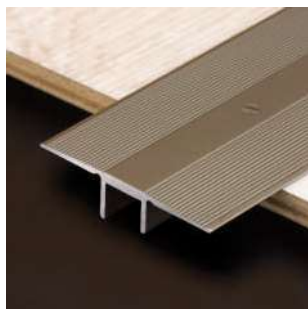

HEAVY DUTY ALUMINIUM SCREWFIX EXPANSION COVER

2.7m length

CODE	SIZE (w/d)	DESCRIPTION
ASCE410	41mm x 9mm	Aluminium Screw Fix Expansion Cover

The Aluminium Screw Fix Expansion Cover is popular in commercial projects due to the strength of screw fixing the Cover in medium to high traffic areas. The Expansion Cover is used between two hard floors of equal height and is screw fixed directly into the screed, which allows for some height adjustment. The Expansion Cover protects the two floor edges and allows for movement with laminate and wood flooring. The Expansion Cover is supplied undrilled to allow the installer some freedom on site when determining spacing between fixing points. Available in certain anodised colours. Not all anodised colours are kept in stock, however on special order all anodised colours can be ordered with an expected lead time.

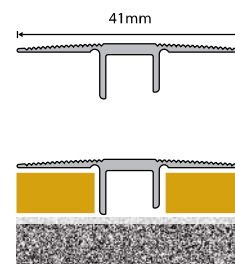

HEAVY DUTY ALUMINIUM SCREWFIX END COVER

2.7m length

CODE	SIZE (w/d)	DESCRIPTION
ASCSQ280	28mm x 8mm	Aluminium Screw Fix End Cover

The Aluminium Screw Fix End Cover is used in commercial or domestic projects against vertical obstructions like shop fronts, sliding doors, walls and built in cupboards. The End Cover is screw fixed directly into the screed. The End Cover protects the floor edge and allows for movement with laminate and wood flooring. The End Cover is supplied undrilled to allow the installer some freedom on site when determining spacing between fixing points. Available in certain anodised colours. Not all anodised colours are kept in stock, however on special order all anodised colours can be ordered with an expected lead time.

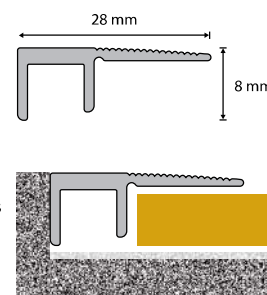

HEAVY DUTY ALUMINIUM SCREWFIX TRANSITION COVER

2.7m length

CODE	SIZE (w/d)	DESCRIPTION
ASCT460	46mm x 11mm	Aluminium Screw Fix Transition Cover

The Aluminium Screw Fix Transition Cover is used in commercial and domestic projects where there is a height variance of approximately 5mm. The Transition Cover is screw fixed directly into the screed which allows for some height adjustment. The Transition Cover protects both floor edges and allows for movement with laminate and wood flooring. The Transition Cover is supplied undrilled to allow the installer some freedom on site when determining spacing between fixing points. Available in certain anodised colours. Not all anodised colours are kept in stock, however on special order all anodised colours can be ordered with an expected lead time.

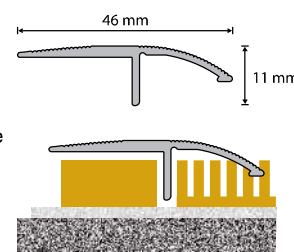

ALUMINIUM TILE-IN RAMP

CODE	SIZE (width)	DESCRIPTION
ATIR100	10mm	Aluminium Tile-In Ramp (8-9mm thick tile)
ATIR120	12mm	Aluminium Tile-In Ramp (10-11mm thick tile)
AFTIR100	10mm	Aluminium Formable Tile-In Ramp (8-9mm thick tile)
AFTIR120	12mm	Aluminium Formable Tile-In Ramp (10-11mm thick tile)

The M-Trim Aluminium Tile-In Ramp provides a smooth transition between floor coverings of different heights. Available in a formable version on request. This ramp is suitable for foot traffic and may not be suitable for all trolley traffic, especially if trolleys are heavy or have hard wheels.

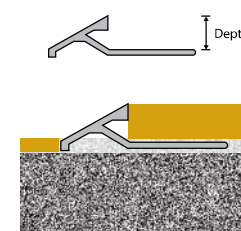



ALUMINIUM WIDE TILE-IN RAMP

CODE	SIZE (w/d)	DESCRIPTION
AWTIR100	52mm x 10mm	Aluminium Wide Tile-in Ramp for 8-9mm tile
AWTIR120	52mm x 12mm	Aluminium Wide Tile-in Ramp for 10-11mm tile

The Aluminium Wide Tile-in Ramps are used to compensate for differences in height between tiled and other flooring types. A smooth inclined junction between the two types of flooring protecting the edge of the tiles from damage. Used in high pedestrian and trolley traffic inside or outside the building in shopping centres, airports and public buildings.

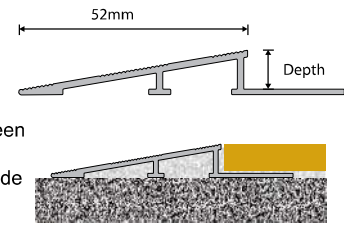

ALUMINIUM RETRO-FIT RAMP

CODE	SIZE (w/d)	DESCRIPTION
ARR100	52mm x 10mm	Aluminium Retro-fit Ramp

The M•Trim Aluminium Retro-fit Ramp is used after the tiled, carpeted or wooden floor has been completed and a pedestrian traffic ramp is required. The Aluminium Retro-fit Ramp is affixed using an appropriate adhesive.

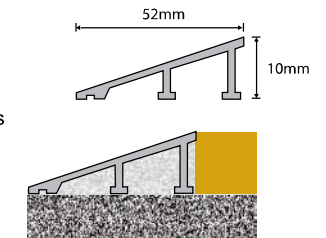

ALUMINIUM RETRO-FIT WIDE RAMP

CODE	SIZE (w/d)	DESCRIPTION
ARWR100	110mm x 10mm	Aluminium Retro-fit Wide Ramp for 8-15mm tiles

The M•Trim Retro-fit Wide ramp is used after the tiled, carpeted or wooden floor has been completed and a pedestrian and trolley traffic ramp is required. Can be used for wheelchairs. The Aluminium Retro-fit Wide ramp can be packed with adhesive to meet a 8 to 15mm tile. Fix ramp using appropriate adhesives.

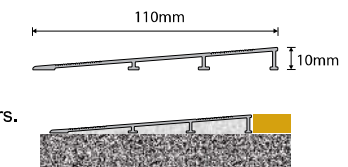

ALUMINIUM LAMINATE TRIMS



ALUMINIUM LAMINATE SQUARE NOSING

CODE	SIZE (depth)	DESCRIPTION
ASQN080	8mm	Aluminium Square Nosing

The Aluminium Square Nosing is designed for use with laminate flooring, but can be used with other flooring types as well. The Square Nosing can be screw fixed in place. The riser lip covers the riser flooring material and gives a consistent finish, even on open stairs. The flooring is fitted in under the tread for a neat finish. Available in certain anodised colours. Not all anodised colours are kept in stock, however on special order all anodised colours can be ordered with an expected lead time.

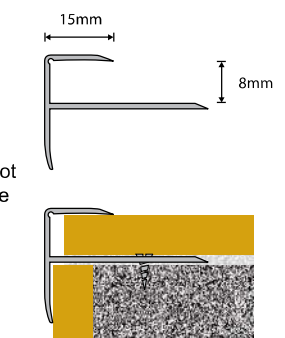



Pictured with base

ALUMINIUM LAMINATE EXPANSION COVER

90cm and 2.7m lengths

CODE	SIZE (width)	DESCRIPTION
ACE380	38mm	Aluminium Wood/Laminate Expansion Cover

M•Trim Aluminium Wood/Laminate Expansion Cover is used to allow for movement for the same level wood/laminate flooring for thicknesses from 7mm to 16mm. The M•Trim expansion cover is fitted into the 8mm, 10mm or 14mm base dependant on the thickness of the flooring. Available in certain anodised colours. Not all anodised colours are kept in stock, however on special order all anodised colours can be ordered with an expected lead time. Bases sold separately.

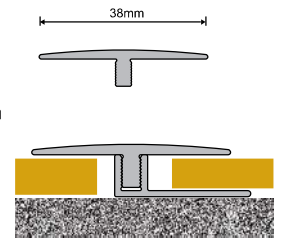

Pictured with base

ALUMINIUM LAMINATE TRANSITION COVER

90cm and 2.7m lengths

CODE	SIZE (w/d)	DESCRIPTION
ACT380	38mm x 6mm	Aluminium Wood/Laminate Transition Cover

M•Trim Aluminium Wood/Laminate Transition Cover is used as a transition between wood/laminate and different height flooring such as a transition between wood/laminate and carpet. The height difference can be up to 6mm. The M•Trim transition cover is fitted into the 8mm, 10mm or 14mm base dependant on the thickness of the flooring. Available in certain anodised colours. Not all anodised colours are kept in stock, however on special order all anodised colours can be ordered with an expected lead time. Bases sold separately.

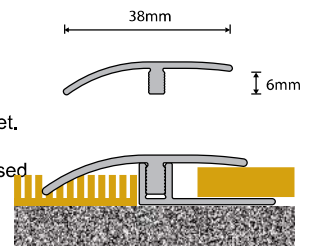

ALUMINIUM LAMINATE FINISH COVER

90cm and 2.7m lengths

CODE	SIZE (w/d)	DESCRIPTION
ACF400	40mm x 10mm	Aluminium Wood/Laminate Finish Cover

M•Trim Aluminium Wood/Laminate Finish Cover is used as a ramp (finish) between wood/laminate down to a screed or vinyl. The height difference can be up to 10mm. The M•Trim Finish cover is fitted into the 8mm, 10mm and 14mm base dependant on the thickness of the flooring. Available in certain anodised colours. Not all anodised colours are kept in stock, however on special order all anodised colours can be ordered with an expected lead time. Bases sold separately.

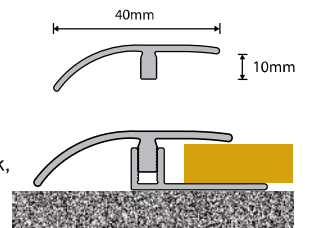

ALUMINIUM LAMINATE SQUARE END COVER

90cm and 2.7m lengths

CODE	SIZE (width)	DESCRIPTION
ACSQ248	24mm	Aluminium Wood/Laminate Square End Cover

M•Trim Aluminium Wood/Laminate Square End Cover is used as an end cover against walls, sliding doors to allow for movement in the wood/laminate floors for thicknesses from 7mm to 16mm. The M•Trim Square End cover is fitted into the 8mm, 10mm or 14mm base dependant on the thickness of the flooring. Available in certain anodised colours. Not all anodised colours are kept in stock, however on special order all anodised colours can be ordered with an expected lead time.

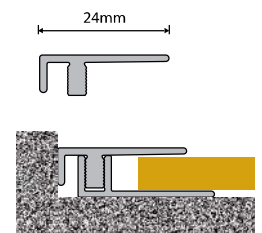

ALUMINIUM LAMINATE BASE - sold seperately

90cm and 2.7m lengths

CODE	SIZE (depth)	DESCRIPTION
ACB080	8mm	Aluminium Cover Base
ACB100	10mm	Aluminium Cover Base
ACB140	14mm	Aluminium Cover Base

M•Trim Aluminium Cover Base is used as the base to fit the Aluminium Expansion, Transition, Finish and Square End covers for wood/laminate flooring. The aluminium cover base allows for different thickness floors from 7mm to 16mm.

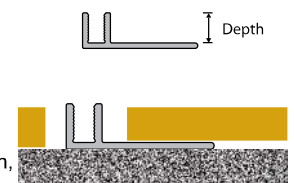

ALUMINIUM FOILED TRIMS

All Laminate Trims are available in 2.7m lengths unless otherwise specified.

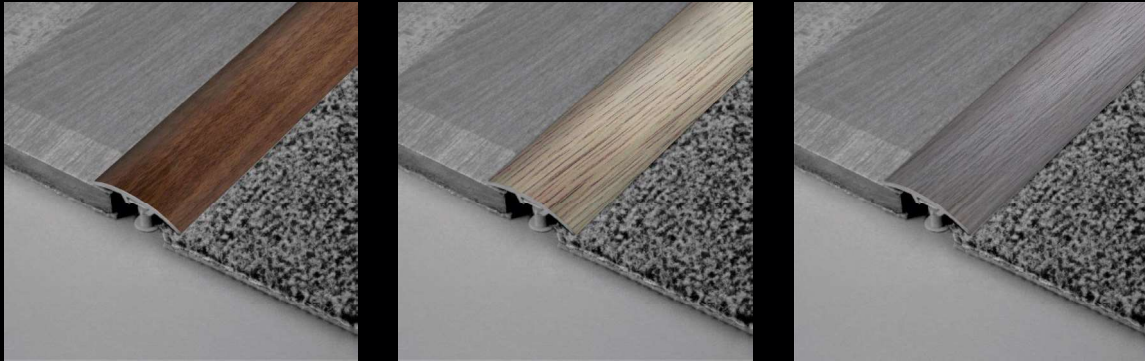

MTRIM FOILED COLOURS



SAND

SAND

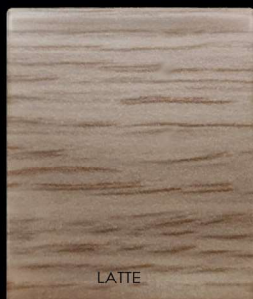

LATTE

LATTE



GREY OAK

GREY OAK



WHITEWASHED
VERANDA

WHITEWASHED VERANDA

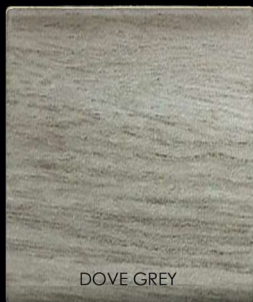

DOVE GREY

DOVE GREY

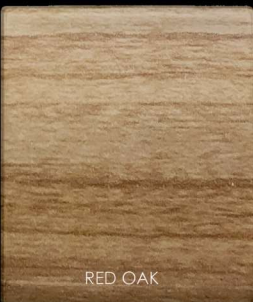

RED OAK

RED OAK

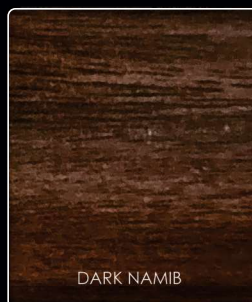

DARK NAMIB

DARK NAMIB



WALNUT

WALNUT

This is a PVC foil that is 200 micron thick. In terms of abrasion resistance it tests to 4000 revolutions in the standard tabor test which is equal to AC4 rating.

A standard guarantee would be 1 year under normal wear in a domestic application, each case would need to be assessed individually.

Please note that the colour representation in this catalogue is an approximation and is as close as the printing process will allow. Kirk Marketing does not in any way guarantee that the colours in this catalogue are an exact match to the finished product. Kirk Marketing reserves the right in its absolute discretion to vary any specification or design, and to supply products which are in our sole opinion, equivalent to those being offered to the purchaser.

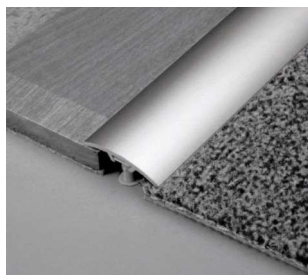

ALUMINIUM MULTI-PURPOSE COVER 38MM

90cm, 1.8m, 2.7m lengths

CODE	SIZE	DESCRIPTION
AMC380	38mm(W) x 5mm(H)	Aluminium Cover Base

Retro-fit Expansion Cover for all flooring types in domestic and light commercial applications with a 38mm sight line. Hidden dowel fixing holds cover in place using a 6mm hole. Available in anodized, powder coated and wood foil colours.

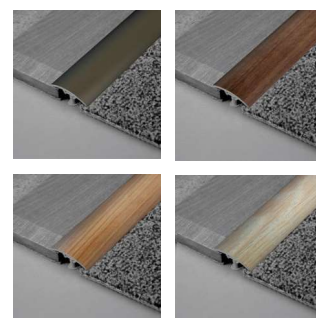
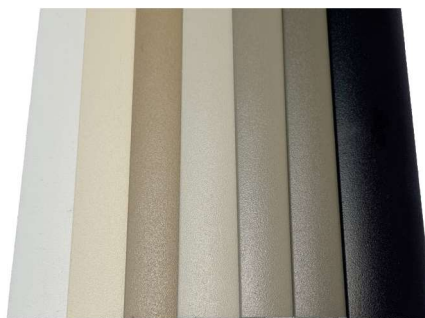
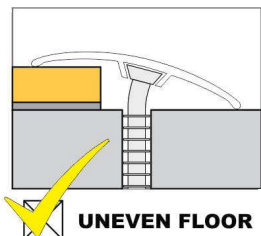
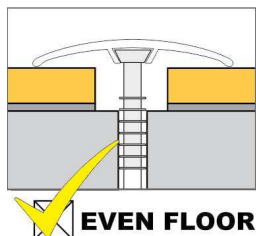

ALUMINIUM END COVER 8MM

90cm and 2.7m lengths

CODE	SIZE (depth)	DESCRIPTION
AEC080	8mm	Aluminium End Cover

End Cover for laminate floors with 8.3mm height (7-8mm thick laminate flooring). 14x11mm sight line. Used against sliding doors and walls, profile is glued in place. Available in anodized finishes.

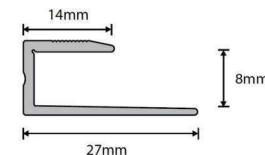

ALUMINIUM CARPET STRAIGHT GRIP

CODE	SIZE (depth)	DESCRIPTION
ACGSE100	10mm	Aluminium Carpet Gripper Straight Edge Trim

M•Trim Aluminium Carpet Gripper Straight Edge is used between stretch carpet and tile or wood. It's main purpose is as a transition between carpet and another flooring type of similar thickness in order to protect the carpet and the other flooring material. The Aluminium Carpet Gripper Straight Edge is nailed to the floor and the carpet is stretched onto the gripper under the lip and if required the top is knocked down to meet the carpet thickness with rubber mallet and wood block. Available in certain anodised colours. Not all anodised colours are kept in stock, however on special order all anodised colours can be ordered with an expected lead time.

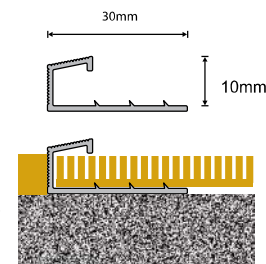

ALUMINIUM CARPET ROUND GRIP

CODE	SIZE (depth)	DESCRIPTION
ACGRE100	11mm	Aluminium Carpet Gripper Round Edge Trim

M•Trim Aluminium Carpet Gripper Round Edge is used as a finishing transition between stretch carpet and screed or vinyl. Front door entrances, bedroom entrances, etc. The Aluminium Carpet Gripper Round Edge is nailed to the floor and the carpet is stretched onto the gripper under the lip and if required the top is knocked down to meet the carpet thickness with rubber mallet and wood block. Available in certain anodised colours. Not all anodised colours are kept in stock, however on special order all anodised colours can be ordered with an expected lead time.

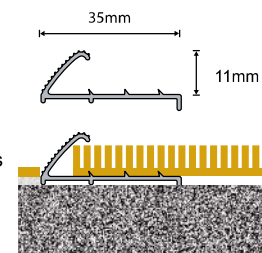



ALUMINIUM CARPET TRANSITION GRIP

CODE	SIZE (w/d)	DESCRIPTION
ACGCS300	30mm x 9mm	Aluminium Carpet Gripper Capping Strip Trim

M•Trim Aluminium Carpet Gripper Capping Strip is used as a variable thickness transition between stretch carpet and laminate or wood or tile. The Aluminium Carpet Gripper Capping Strip is nailed to the floor and the carpet is stretched onto the gripper under the lip and if required the top is knocked down to meet different thickness carpet and laminate or wood or tile thickness with a rubber mallet and wood block. With the floating laminate and wood floors the capping strip allows for movement. Available in certain anodised colours. Not all anodised colours are kept in stock, however on special order all anodised colours can be ordered with an expected lead time.

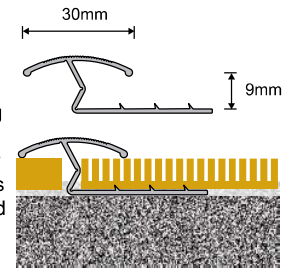

ALUMINIUM CARPET WOOD GRIP

CODE	SIZE (w/d)	DESCRIPTION
ACGT-W100	19mm x 10mm	Aluminium Carpet Gripper Transition to Wood/Tile

M•Trim Aluminium Carpet Gripper Transition to Wood/Tile is used as a fixed thickness transition between stretch carpet and wood or laminate or tile. The Aluminium Carpet Gripper Transition to Wood/Tile is nailed to the floor and the carpet is stretched onto the gripper under the lip and if required the top is knocked down to meet the carpet thickness with a rubber mallet and wood block. The Wood/ Tile/Laminate side is a fixed thickness. The fixed side allows for movement for the floating laminate and wood floors. Available in certain anodised colours. Not all anodised colours are kept in stock, however on special order all anodised colours can be ordered with an expected lead time.

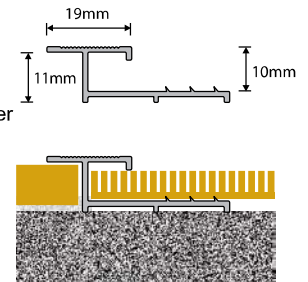

CARBORUNDUM STRIPS

CODE	SIZE (width x length)	DESCRIPTION
CARB190	19mm x 3m	Carborundum Strip - Black and Luminescent
CARB250	25mm x 3m	Carborundum Strip - Black
CARB500	50mm x 3m	Carborundum Strip - Black and Yellow Chevron

The M•Trim Carborundum strips are available in three different widths 19mm, 25mm and 50mm. They are self adhesive strips in 3m and 50m rolls suitable for indoor and outdoor use. Adhering to most flooring surfaces, tiles, vinyl, screed and laminate, as well as to the M•Trim aluminium nosing, ARC450 as a 19mm Carborundum strip.

Make sure the surfaces have been thoroughly cleaned before the Carborundum strips are adhered.





ALUMINIUM CORNER PROTECTOR / END COVER (4 in 1 Trim)

2.7m length

CODE	SIZE (depth)	DESCRIPTION
ACPE052	5,2mm	Aluminium Corner Protector End Cover

The Aluminium Corner Protector End Cover is a multi-purpose profile used with all wall and floor finishes up to 5mm thick (LVT, vinyl, tiles, mosaics, stick-down carpet and carpet tiles). The profile can be used in a variety of ways. Not all anodised colours are kept in stock, however on special order all anodised colours can be ordered with an expected lead time.

Corner Protector – The profile is suitable for use with thin wall tiles or mosaics as a corner protector. The symmetrical design gives a neat finish and a complementary anodised colour gives the perfect solution to all external corners. Not all anodised colours are kept in stock, however on special order all anodised colours can be ordered with an expected lead time.

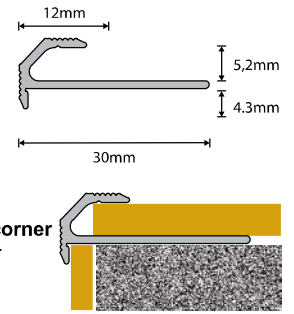

Stair-Nosing – The profile can be screw fixed or tiled in to the tread before fitting the required flooring type. The riser lip allows the profile to be fitted on open stairs to give a consistent finish. The flooring is fitted in under the tread for a neat finish. Not all anodised colours are kept in stock, however on special order all anodised colours can be ordered with an expected lead time.

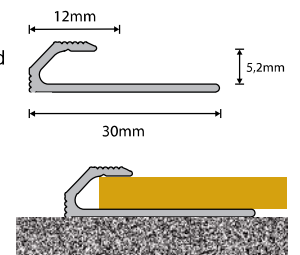

End/Ramp – When LVT, vinyl or other finish ends and a ramp or end profile is required, the riser lip can be removed from the profile to give a safe transition. Run a knife down the groove on the inside of the riser lip and snap the lip off, this leaves an End Profile/Ramp that gives a neat finish and safe transition from the old existing floor up to the new floor. Not all anodised colours are kept in stock, however on special order all anodised colours can be ordered with an expected lead time.

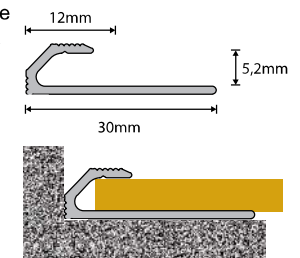

End Cover – The profile can also be used against a wall or other obstruction to finish the floor neatly. The riser lip will have to be removed in this application as well. The profile can be screw fixed or glued in place with an appropriate adhesive.



KIRK Décor

Contemporary profiles for the perfect finish.



UNIVERSAL TILE MATCH

Aluminium POWDER-COATED colours ANODISED colours colours

NEUTRAL

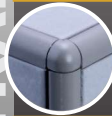

PUTTY

LEAD

PEPPER

EARTH



MATT BRONZE

BRONZE

LEAD

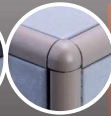

GINGERBREAD

SAND

PUTTY

FEATURE

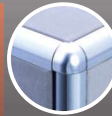

SILVER

MATT SILVER

MATT GOLD

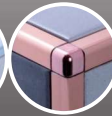

OPAL

MATT BLACK

SALT

PLEASE NOTE: All Kirk Decor MTRIM products only available through tile retailers & hardware stores.

KIRK DECOR MTRIM COLOURS

ANODISED



MATT SILVER
MATT SILVER



MATT CHAMPAGNE
MATT CHAMPAGNE



BRIGHT BRONZE
BRIGHT BRONZE

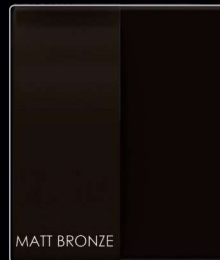

MATT BRONZE
MATT BRONZE



MATT BLACK
MATT BLACK



SILVER
SILVER



MATT GOLD
MATT GOLD



COPPER
COPPER



PUTTY

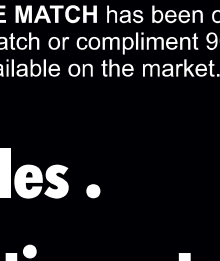

LEAD

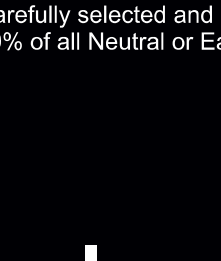

PEPPER

The **UNIVERSAL TILE MATCH** has been carefully selected and formulated to either match or compliment 90% of all Neutral or Earth tone tile selections available on the market.

5 profiles . 3 connecting external corner pieces .

POWDER COATED

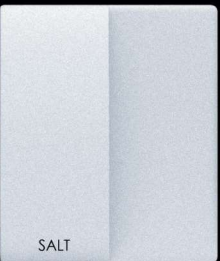

SALT
SALT

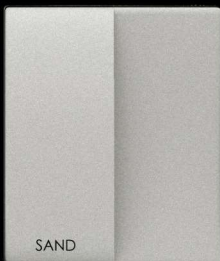

SAND
SAND

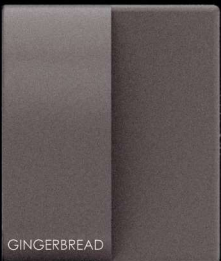

GINGERBREAD
GINGERBREAD

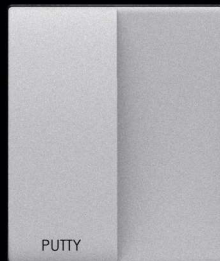

PUTTY



LEAD



PEPPER

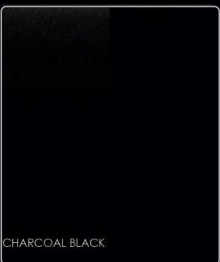

CHARCOAL BLACK
CHARCOAL BLACK





ROUNDED SQUARE EDGE

ASQE100R

ASQE120R

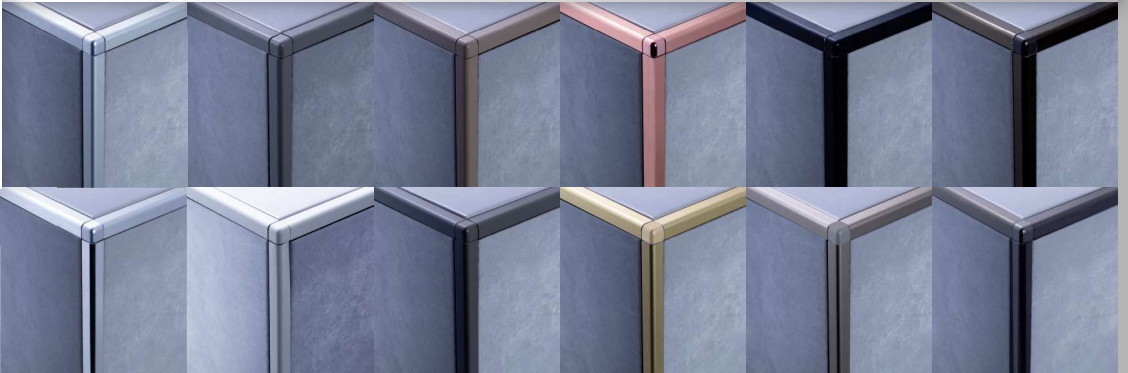

CODE	SIZE (w/d)	DESCRIPTION
ASQE100R	30mm x 11mm	10mm Rounded Square Edge
ASQE120R	30mm x 13mm	12mm Rounded Square Edge

Rounded Square Edge offers an aesthetic finish to tile edges. It protects the tile Edge and is used for decorative purposes. No more mitering and sharp corners. The corner piece offers a safe and aesthetic corner and finish.



TRIANGULAR EDGE

ATE100

ATE120

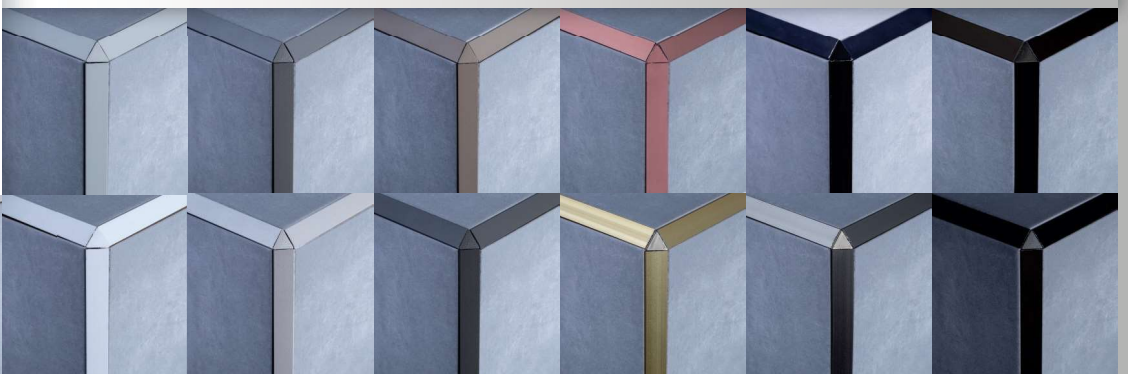

CODE	SIZE (w/d)	DESCRIPTION
ATE100	31mm x 11mm	10mm Triangle Edge Bright
ATE120	31mm x 13mm	12mm Triangle Edge Bright

Triangular Edge offers an aesthetic finish to tile edges. It protects the tile Edge and is used for decorative purposes. No more mitering and sharp corners. The corner piece offers a safe and aesthetic corner and finish.



QUADRANT EDGE

AQE100

AQE120

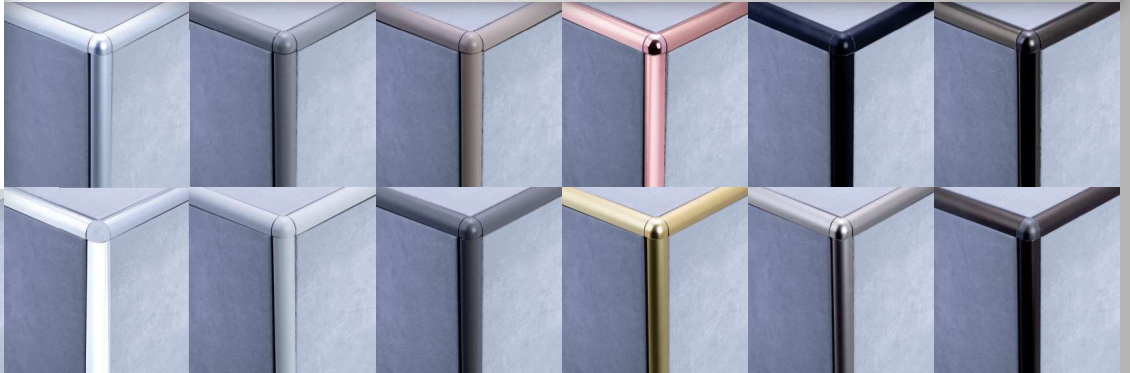

CODE	SIZE (w/d)	DESCRIPTION
AQE100	29mm x 11mm	10mm Quadrant Edge
AQE120	29mm x 13mm	12mm Quadrant Edge

The Aluminium Quadrant Edge Trim offers more face than the Aluminium Round Edge Trim to finish off tile edges. It is used for decorative purposes and for tile edge protection. The AQE 100 and 120 profile is available in some Kirk Decor anodized colours as well as powder coated finishes. The corner piece creates a safe corner with no need for miter cutting.



STRAIGHT EDGE

ASE100

ASE120

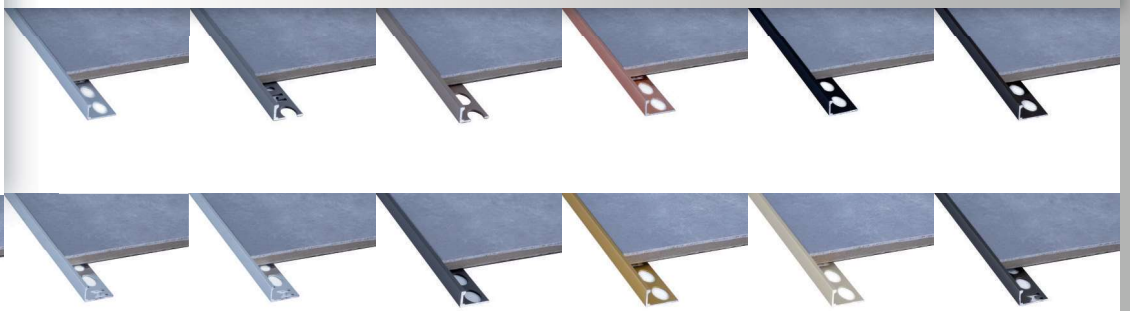

CODE	SIZE (w/d)	DESCRIPTION
ASE100	20mm x 11mm	10mm Straight Edge
ASE120	20mm x 13mm	12mm Straight Edge

The Aluminium Straight Edge Trim is used to protect and decorate the edges of tiled floor and wall surfaces. The ASE100 and ASE120 straight edges are available in the Kirk Decor anodized and powder coated finishes.

LISTELLO

APLI100

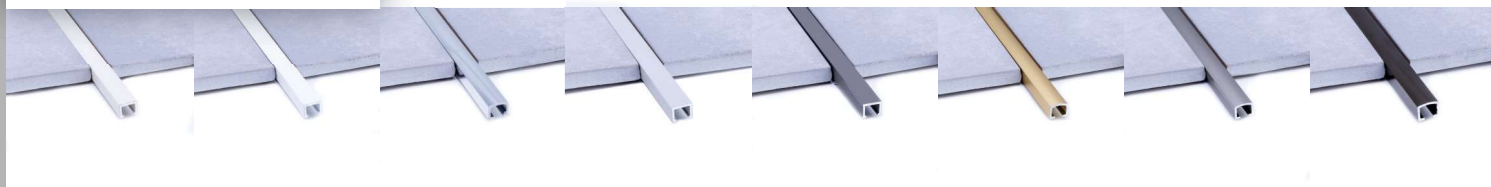
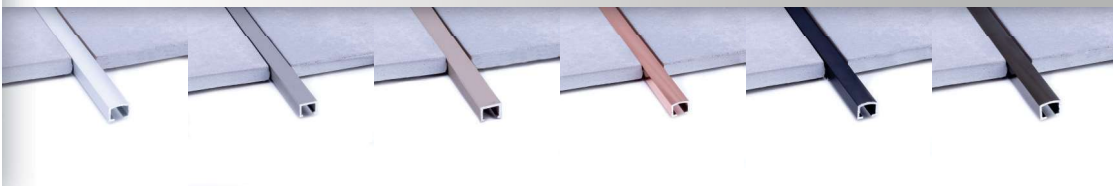

CODE	SIZE (w/d)	DESCRIPTION
APLI100	10mm x 8mm	Aluminium Pencil Listello 10mm

The 10mm Aluminium Pencil Listello is available in the Kirk Decor anodized and powder coated finishes. This pencil listello can be used with all tiles from 8mm upwards. Leave a 14mm gap between tiles and simply press-fit the listello in between tiles to the desired depth.

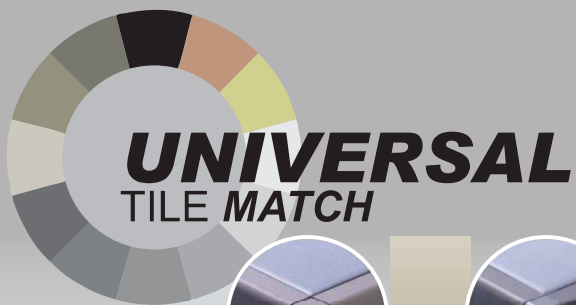

Aluminium

POWDER-COATED colours

ANODISED colours

colours

NEUTRAL

EARTH

FEATURE



PUTTY



MATT BRONZE



GINGERBREAD

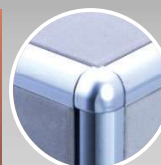

SILVER



COPPER



LEAD



BRONZE



SAND



MATT SILVER

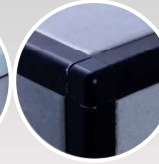

MATT BLACK



PEPPER



MATT CHAMPAGNE



MATT GOLD



SALT

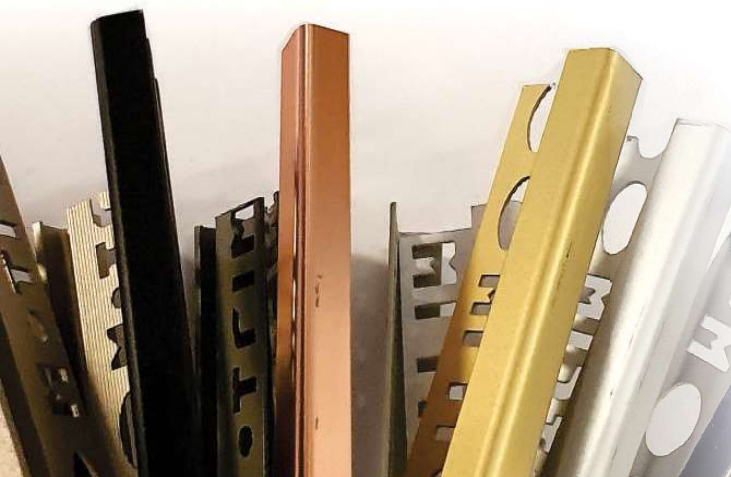

profiles



TRIANGULAR EDGE



QUADRANT EDGE



SQUARE EDGE RADIUS



STRAIGHT EDGE

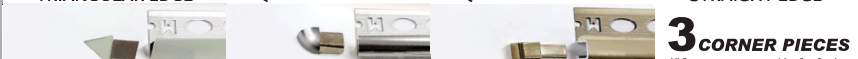

3 CORNER PIECES
All Corners can connect at either 2 or 3 points.

BRASS TRIMS

All Brass Trims are available in 2.5m lengths unless otherwise specified.



MTRIM BRASS COLOURS

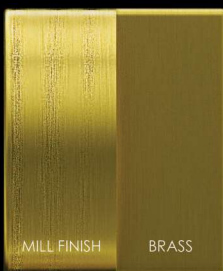

MILL FINISH



BRUSHED



POLISHED SHEET



Brass Trims will oxidize in the presence of oxygen and moisture. This oxidation will create a unique patina on the surface of the trims and can be a variety of colours like black and green. The trims would need to be cleaned regularly to reduce the effect of the oxidation. Brass polishes will change the look of extruded brass to look more shiny. In the case of heavy oxidation, rubbing the trims with a Scotchbrite pad will help remove the surface oxidation but there will be a slight brushed finish.



BRASS STRAIGHT EDGE TRIM

CODE	SIZE (depth)	DESCRIPTION
BSE080	8mm	Brass Straight Edge Trim (6-7mm thick tile)
BSE100	10mm	Brass Straight Edge Trim (8-9mm thick tile)
BSE120	12mm	Brass Straight Edge Trim (10-11mm thick tile)
BSE150	15mm	Brass Straight Edge Trim (13-14mm thick tile)
BSE225	22.5mm	Brass Straight Edge Trim (20-22mm thick tile)

The M•Trim Brass Straight Edge Trim is used to protect and/or decorate tiled floors and walls. It can also be used with other floor types and is often used between contrasting flooring such as tiles and wood. The Brass Straight Edge Trim is a medium to heavy duty edge trim that can endure heavy pedestrian traffic. It is available in a range of depths. As brass can oxidize, please note that this can be rectified using polishing agents.

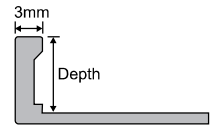

FORMABLE BRASS STRAIGHT EDGE TRIM

CODE	SIZE (depth)	DESCRIPTION
BFE080	8mm	Brass Formable Straight Edge Trim (6-7mm thick tile)
BFE100	10mm	Brass Formable Straight Edge Trim (8-9mm thick tile)
BFE120	12mm	Brass Formable Straight Edge Trim (10-11mm thick tile)
BFE150	15mm	Brass Formable Straight Edge Trim (13-14mm thick tile)
BFE225	22.5mm	Brass Formable Straight Edge Trim (20-22mm thick tile)

The M•Trim Brass Formable Straight Edge Trim can be formed into curves using hand pressure. Once the desired shape has been achieved the trim can be fixed using concrete nails or screws. As brass can oxidize, please note that this can be rectified using polishing agents.

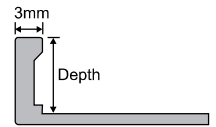

BRASS FLAT BAR

CODE	SIZE (depth)	DESCRIPTION
BFB253	25mm x 3mm	Brass Flat Bar
BFB303	30mm x 3mm	Brass Flat Bar
BFB403	40mm x 3mm	Brass Flat Bar
BFB503	50mm x 3mm	Brass Flat Bar

M•Trim Brass Flat Bar is used as a dividing strip fitted as a Retro-fit or tiled in with the screed and tile. Can be used in matwells. The Flat bar is available in 3mm thickness and different depths. The Brass is a natural finish.

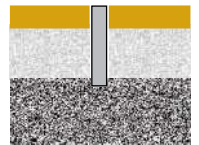
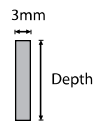

BRASS SQUARE BAR

CODE	SIZE (w/d)	DESCRIPTION
BQB100	10mm x 10mm	Brass Square Bar

The M•Trim Brass Square Bar 10mm thick is used as a divider between tiles on a floor. The Brass finish is natural. It can be bent to form a gentle curve. This is great for designers giving them more freedom in design with brass. The M•Trim Brass Square Bar is fitted after the tiles have been laid.

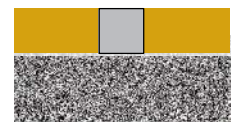
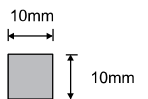

BRASS SQUARE EDGE TRIM

2m length

CODE	SIZE (w/d)	DESCRIPTION
BQE080	8mm x 8mm	Brass Square Edge Trim (6-7mm thick tile)
BQE100	8mm x 10mm	Brass Square Edge Trim (8-9mm thick tile)
BQE120	8mm x 12mm	Brass Square Edge Trim (10-11mm thick tile)
BQE150	8mm x 15mm	Brass Square Edge Trim (13-14mm thick tile)
BQE200	8mm x 20mm	Brass Square Edge Trim (18-19mm thick tile)

The M•Trim Brass Square Edge Trim can be used as a stairnosing, edging rail and as a corner protector. This M•Trim is a very tough edge protector offering an aesthetic finish. As brass can oxidize, please note that this can be rectified using polishing agents. Only available in 2m lengths with a polished finish.

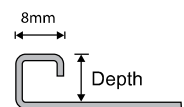



BRASS ROUND EDGE TRIM

CODE	SIZE (depth)	DESCRIPTION
BRE100	10mm	Brass Round Edge Trim (For 8-9mm thick tile)
BRE120	12mm	Brass Round Edge Trim (For 10-11mm thick tile)

The M•Trim Brass Round Edge Trim has a round face that offers an aesthetic finish to wall and floor tiles. This M•Trim is available in a variety of depths. It is used for decorative purposes and for protecting the tiled edges on wall and floor tiles. As brass can oxidize, please note that this can be rectified using polishing agents.

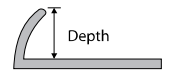

BRASS RETRO-FIT CORNER PROTECTOR

2m length

CODE	SIZE (w/d)	DESCRIPTION
BCP300	30mm x 30mm	Brass Retro-fit Corner Protector
BCP500	50mm x 50mm	Brass Retro-fit Corner Protector

The M•Trim Brass Corner Protector is retrospectively fixed using appropriate adhesives. It protects external corners and is affixed after the wall covering has been applied. Especially useful in renovations, the Brass Corner Protector can be used to cover damaged wall corners, creating an aesthetically pleasing finish. The Brass Corner Protector is supplied in a polished finish.

Unique sizes and angles are possible with minimum orders of 100 lengths. Only available in 2m lengths with a polished finish. M•Trim PVC, Aluminium and Stainless Steel Corner Protectors are also available. Please refer to appropriate categories.

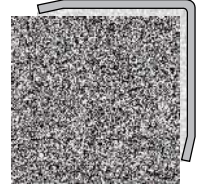
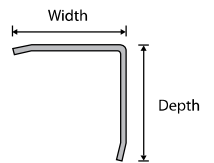

BRASS TILE-IN STAIR-NOSING

CODE	SIZE (w/d)	DESCRIPTION
BTIN100	16mm x 10mm	Brass Tile-in Stair nosing (8-9mm thick tile)

This M•Trim Brass Tile-in Stair-nosing is installed during tiling and acts as an excellent tile-in stairnosing for domestic and commercial use. Ideal for heavy pedestrian traffic. Used for tiles of between 8 and 9mm thick.

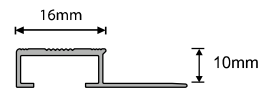

BRASS TILE-IN RAMP

CODE	SIZE (depth)	DESCRIPTION
BTIR100	10mm	Brass Tile-in Ramp (8-9mm thick tile)

The M•Trim Brass Tile-In Ramp provides a smooth transition between floor coverings of different heights. As brass can oxidize, please note that this can be rectified using polishing agents.

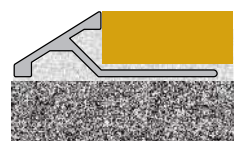

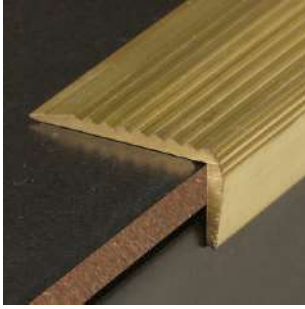

BRASS RETRO-FIT STAIR-NOSING

CODE	SIZE (w/d)	DESCRIPTION
BRN340	34mm x 17mm	Brass Retro-fit Stair nosing

The M•Trim Brass Retro-fit Stair-nosing is used on existing tiled stairs, for new stairways and refurbishments to protect the tiles from breaking and chipping. This Brass Stair-nosing is available in a natural finish and is screw fixed and/or affixed using appropriate adhesives onto the various stair materials. The M•Trim Brass Retro-fit Stair-nosing is slip resistant and highly visible, reducing the possibility of accidents. Used for medium to heavy duty pedestrian traffic.

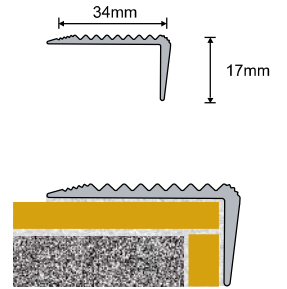

BRASS TRANSITION COVER

CODE	SIZE (w/d)	DESCRIPTION
BTC340	34mm x 10mm	Brass Transition Cover

The M•Trim Brass Transition Cover is used as a transition cover between different height floor coverings such as: tile or wood/laminate and screed or vinyl or carpet at entrances where there is heavy pedestrian traffic. It is also used for aesthetic design where a wooden/laminate or tile floor ends and you need a trim to finish it off.

Great for refurbishments, The Brass is available in a natural finish, The Brass Tile to Carpet cover is a Retro-fit , screw fixed with brass screws and plugs. The transition has a height difference of 8mm.

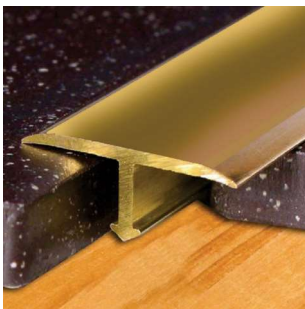
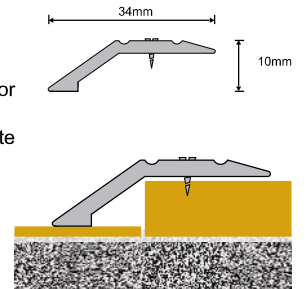

BRASS CAPPING STRIP 25x8mm NATURAL

BASE

CODE	SIZE (width)	DESCRIPTION
BCS250.N	25mm	Brass T-Piece used between tiles and other floor finishes

The M•Trim Brass T-Piece used between tiles and other floor finishes. 25mm Sightline and 8mm leg. Natural brass finish.

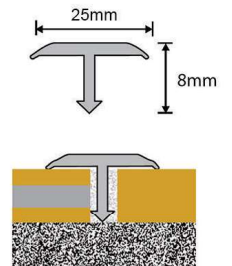

BRASS TRANSITION COVER

CODE	SIZE (width)	DESCRIPTION
BTC380	38mm	Brass Transition Cover

The M•Trim Brass Transition Cover has a curved face which makes it suitable for transitions between all flooring types. Cover is used for medium to heavy duty pedestrian traffic. Great for refurbishments. The Brass is available in a natural finish. The Brass Cover is a Retro-fit profile and is screw fixed with brass screws and plugs.

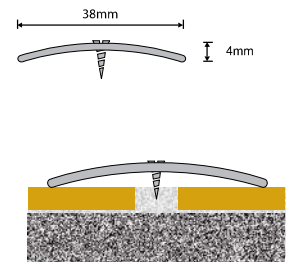

BRASS STAIR ROD

CODE	SIZE (length)	DESCRIPTION
BSR090.89	89cm	Stair Rod including end clips
BSR090.120	120cm	Stair Rod including end clips

The M•Trim steel stair rod is used on carpet stairways to hold runner carpet in place up the stairs at the base of each step riser. Each stair rod comes with a pair of brass clips and brass ends to finish off the stair rod. The stair rod is both functional and used for aesthetics. The steel stair rod comes in a polished brass finish.

MTRIM STAINLESS STEEL FINISHES



STAINLESS STEEL TRIMS

Stainless Steel Trims are available in 2.5m lengths in grade 430 brushed or polished stainless steel, unless otherwise specified. Grade 316 is recommended in coastal regions.

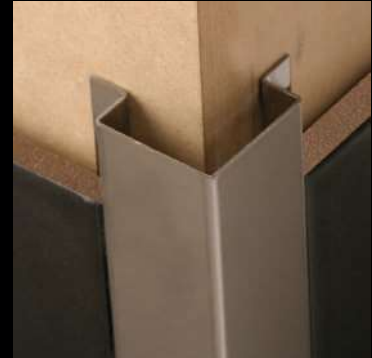

Stainless steel is one of humankind's greatest achievements. This steel offers many advantages to the architect, designer and home owner when considering it for floor and wall finishes. Stainless steel is available in many grades and surface finishes to add value to floor and wall finishes, the selection of the correct grade and surface finish is an important consideration.

The standard grade being used locally is grade 430 in a polished finish. This grade of stainless steel is suitable for use in most areas, most commonly internal, and is popular because of the corrosion resistance and highly polished finish. This grade is also available in a brushed finish which does not show finger prints so is suitable for public areas in commercial buildings where regular specific cleaning is not always possible.

Grade 304 is an option for profiles but it only offers slightly more corrosion resistance than grade 430 and the benefit to cost ratio is so slight that it doesn't warrant the consideration.

For coastal and highly corrosive environments grade 316 is the suitable grade. This grade is commonly known as marine grade stainless steel and has added constituents that make it more resistant to corrosion. This grade is available in a matt satin finish or in a brushed finish. Grade 316 should be considered for external applications because of its superior corrosion resistance. Grade 316 is non-magnetic and should be specified in applications where sensitive machinery is in use.

If in doubt about the specific grade and finish to use, contact a Kirk Marketing representative for assistance.

All grades of stainless steel can rust/oxidize and for this reason all profiles must be treated with care before, during and after installation. Stainless steel cannot tolerate cement adhesive, grout and muriatic cleaners. These must be removed immediately after exposure to prevent staining and rusting. All stainless steel is supplied with a lazer film attached to the face, this film is there to protect the face surface from scratches and damage. The installer should leave the film on for as long as possible to ensure the integrity of the face surface. If profiles have been damaged or show signs of corrosion there are some remedies available, please make contact with a Kirk Marketing representative to offer solutions to common problems encountered.



STAINLESS STEEL STRAIGHT EDGE

CODE	SIZE (depth)	DESCRIPTION
SSE066	6.6mm	Stainless Steel Straight Edge Trim (For 4-5mm thick tile)
SSE080	8mm	Stainless Steel Straight Edge Trim (For 6-7mm thick tile)
SSE100	10mm	Stainless Steel Straight Edge Trim (For 8-9mm thick tile)
SSE120	12mm	Stainless Steel Straight Edge Trim (For 10-11mm thick tile)
SSE150	15mm	Stainless Steel Straight Edge Trim (For 13-14mm thick tile)
SSE225	22.5mm	Stainless Steel Straight Edge Trim (For 20-22mm thick tile)
SSE250	25mm	Stainless Steel Straight Edge Trim (For 23-24mm thick tile)

The M•Trim Stainless Steel Straight Edge trim is used for protecting and decorating the edges of tiled floor and wall surfaces. It can be used with other floor materials and applications. It is often used between different flooring materials such as tile and wood. The Straight Edge is available in a range of depths. The Stainless Steel Straight Edge is a heavy duty edge trim and can be used for heavy duty pedestrian traffic. In highly corrosive environments, grade 316 stainless steel is recommended and is available on request. Available in brush finish on request, with lead times.

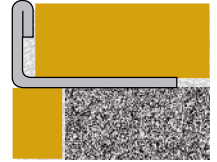
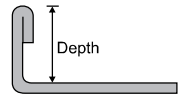

STAINLESS STEEL FORMABLE STRAIGHT EDGE TRIM

CODE	SIZE (d)	DESCRIPTION
SFE066	6.6mm	Stainless Steel Formable Straight Edge Trim (4-5mm thick tile)
SFE080	8mm	Stainless Steel Formable Straight Edge Trim (6-7mm thick tile)
SFE100	10mm	Stainless Steel Formable Straight Edge Trim (8-9mm thick tile)
SFE120	12mm	Stainless Steel Formable Straight Edge Trim (10-11mm thick tile)
SFE150	15mm	Stainless Steel Formable Straight Edge Trim (13-14mm thick tile)
SFE225	22mm	Stainless Steel Formable Straight Edge Trim (20-22mm thick tile)
SFE250	25mm	Stainless Steel Formable Straight Edge Trim (23-24mm thick tile)

The M•Trim Stainless Steel Formable Trim can be formed into curves by using hand pressure. Once the desired shape has been achieved the trim can be fixed using concrete nails or screws. In highly corrosive environments, grade 316 stainless steel is recommended and is available on request.

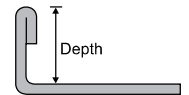

STAINLESS STEEL SQUARE EDGE

CODE	SIZE (w/d)	DESCRIPTION
SQE1010	10mm x 10mm	Stainless Steel Square Edge Trim (8-9mm thick tile)
SQE1210	10mm x 12mm	Stainless Steel Square Edge Trim (10-11mm thick tile)
SQE080	8mm x 8mm	Stainless Steel Square Edge Trim (6-7mm thick tile)
SQE100	8mm x 10mm	Stainless Steel Square Edge Trim (8-9mm thick tile)
SQE120	8mm x 12mm	Stainless Steel Square Edge Trim (10-11mm thick tile)
SQE150	8mm x 15mm	Stainless Steel Square Edge Trim (13-14mm thick tile)
SQE200	8mm x 20mm	Stainless Steel Square Edge Trim (18-19mm thick tile)

The M•Trim Stainless Steel Square Edge Trim can be used as a stair edge, edging rail and as a corner protector. The M•Trim Square Edge Trim is a tough edge protector offering an aesthetic finish. If used on stairs pack with tile adhesive. In highly corrosive environments, grade 316 stainless steel is recommended. All Stainless Steel Square Edge Trims can be supplied in polished, brushed and satin finishes depending on grade.

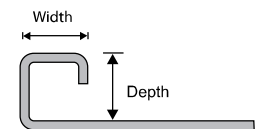

STAINLESS STEEL SQUARE EDGE CORNER PIECES

CODE	SIZE (depth)	DESCRIPTION
SQE080CP	8mm	Corner Piece for SQE080
SQE100CP	10mm	Corner Piece for SQE100
SQE120CP	12mm	Corner Piece for SQE120

The Corner Pieces for Stainless Steel Square Edge Trims offers a neat, safe edge in installations. Mitre cutting can leave dangerous sharp corners, the New Corner Pieces eliminates this threat. The adjoining profiles are butt-joined against the Corner Pieces in Internal and External Corners. Corner Pieces will match the grade and finish of the Stainless Steel Square Edges being used. Lead times may apply for specialized grades and finishes.



STAINLESS STEEL ROUND EDGE

CODE	SIZE (depth)	DESCRIPTION
SRE100	10mm	Stainless Steel Round Edge Trim (8-9mm thick tile)
SRE120	12mm	Stainless Steel Round Edge Trim (10-11mm thick tile)

The M•Trim Stainless Steel Round edge has a semi round face that offers an aesthetic finish to tile edges as well as protection to the tile biscuit. The Stainless Steel round edge finish is polished and is used for decorative purposes and for tile edge protection. The M•Trim Stainless Steel Round Edge is used for light to medium duty pedestrian traffic. In highly corrosive environments, grade 316 stainless steel is recommended. Available in brushed finish on request, with lead times.

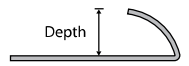

STAINLESS STEEL TILE LISTELLO

CODE	SIZE (w/d)	DESCRIPTION
SLI100	10mm x 10mm	Stainless Steel Tile Listello for wall tile (8-9mm thick tiles)
SLI112	10mm x 12mm	Stainless Steel Tile Listello for wall tile (10-11mm thick tiles)
SLI200	20mm x 10mm	Stainless Steel Tile Listello for wall tile (8-9mm thick tiles)
SLI212	20mm x 12mm	Stainless Steel Tile Listello for wall tile (10-11mm thick tiles)
SLI300	30mm x 10mm	Stainless Steel Tile Listello for wall tile (8-9mm thick tiles)
SLI312	30mm x 12mm	Stainless Steel Tile Listello for wall tile (10-11mm thick tiles)

The M•Trim Stainless Steel Tile Listello is available in different width sections assisting in creating a decorative effect within tile wall coverings. The listellos are installed during tiling. In highly corrosive environments grade 316 stainless steel is recommended and is available on request. Other widths are available on request with a four week lead time. Also available in aluminium. Available in 15mm on request, with lead time. Available in brush finish on request, with lead times.

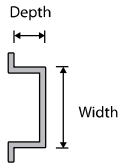

STAINLESS STEEL PENCIL LISTELLO

CODE	SIZE (w/d)	DESCRIPTION
SPLI100	10mm x 6mm	Stainless Steel Listello for wall tile Pencil
SPLI200	20mm x 8mm	Stainless Steel Listello for wall tile Pencil
SPLI300	30mm x 8mm	Stainless Steel Listello for wall tile Pencil

The Pencil Listello version is a retro-fit option and can be used with thicker tiles. Simply press into grout gap to the desired depth. Various surface finishes and grades are available.

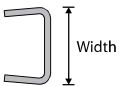

STAINLESS STEEL RETRO-FIT CORNER PROTECTOR

Also available in 3m lengths

CODE	SIZE (w/w)	DESCRIPTION
SCP120	12mm x 12mm	Stainless Steel Retro-fit Corner Protector
SCP300	30mm x 30mm	Stainless Steel Retro-fit Corner Protector
SCP400	40mm x 40mm	Stainless Steel Retro-fit Corner Protector
SCP500	50mm x 50mm	Stainless Steel Retro-fit Corner Protector
SCP750	75mm x 175mm	Stainless Steel Retro-fit Corner Protector

The M•Trim Stainless Steel Wall Corner protector is retrospectively fixed using appropriate adhesives. It is used to provide protection on external corners after the main wall covering or finish has been installed. Especially useful in renovations where damage has already occurred and the corner protector is then used to cover the damage at minimal cost. The M•Trim Wall Corner Protector provides an aesthetically pleasing alternative to major renovations.

Unique sizes and angles are possible on special order. M•Trim PVC, Aluminium and Brass Corner Protectors are also available, please see appropriate categories. In highly corrosive environments, grade 316 stainless steel is recommended and is available on request. Available in brushed finish on request, with lead times.

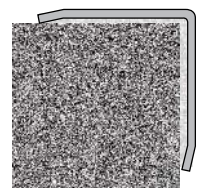
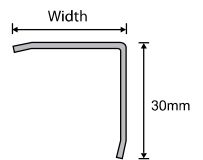

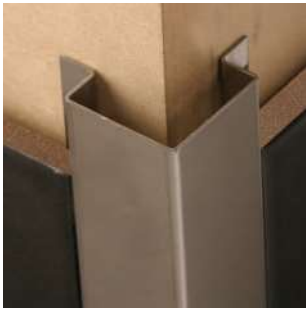

STAINLESS STEEL TILE-IN CORNER PROTECTOR - External Corner

Also available in 3m lengths

CODE	SIZE (w/d)	DESCRIPTION
STICP300	30mm x 10mm	Stainless Steel Tile-in Corner Protector - External Corner
STICP312	30mm x 12mm	Stainless Steel Tile-in Corner Protector - External Corner
STICP500	50mm x 10mm	Stainless Steel Tile-in Corner Protector - External Corner
STICP512	50mm x 12mm	Stainless Steel Tile-in Corner Protector - External Corner
STIRCP300	30mm x 10mm	Stainless Steel Tile-in Corner Protector - External Corner
STIRCP312	30mm x 12mm	Stainless Steel Tile-in Corner Protector - External Corner
STIRCP500	50mm x 10mm	Stainless Steel Tile-in Corner Protector - External Corner
STIRCP512	50mm x 12mm	Stainless Steel Tile-in Corner Protector - External Corner

The M-Trim Stainless Steel Tile-in Corner Protector is fitted with tiles on external walls and columns. The size of corner protector is 30mm x 30mm or 50mm x 50mm. The corner protector is available in a square corner or a rounded corner. It protects external corners of walls and columns against trolleys and general wear and tear. The Stainless Steel Tile-in corner protector is used for decorative purposes as well as protection. Stainless Steel finish is polished. In highly corrosive environments, grade 316 stainless steel is recommended and is available on request. Tile-in corner protectors also available in aluminium. Available in brushed finish on request, with lead times.

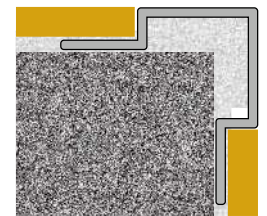
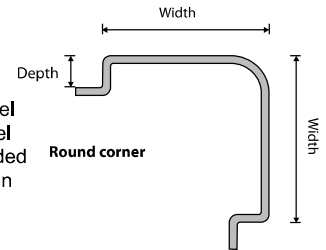
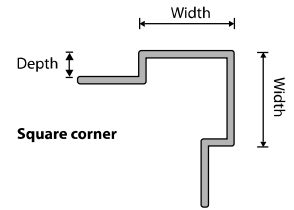

STAINLESS STEEL TILE-IN RAMP

CODE	SIZE (d)	DESCRIPTION
STIR100	10mm	Stainless Steel Tile-in Ramp (8-9mm thick tile)
STIR120	12mm	Stainless Steel Tile-in Ramp (10-11mm thick tile)

The M-Trim Stainless Steel Tile-in Ramp is used to create a safe transition where tiling ends. The standard version is supplied in polished grade 430, suitable for internal use with foot traffic. The brushed finish can also be used to hide scratches and marks from foot traffic. Grade 316 can be used in coastal and corrosive environments. The Stainless Steel Tile-in Ramp is supplied in 2,5m lengths.

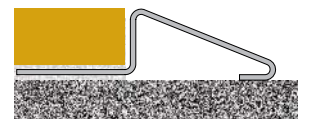
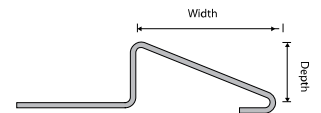

STAINLESS STEEL TILE-IN CORNER PROTECTOR - Internal Corner (SKIRTING)

CODE	SIZE (w/d)	DESCRIPTION
STIICP100	25mm x 10mm	Stainless Steel Tile-in Corner Protector - Internal Corner
STIICP120	25mm x 12mm	Stainless Steel Tile-in Corner Protector - Internal Corner

The M-Trim Stainless Steel Tile-in Internal Corner Protector is fitted with tiles between internal walls and between wall and floor as an internal cove or skirting. The size of the internal corner protector is 25mm x 25mm. It protects internal corners of walls against general wear and tear. The Stainless Steel Tile-in Internal corner protector is used for decorative purposes as well as creating a hygienic corner preventing a dirt trap in kitchens, hospitals and clinics. Stainless Steel finish is polished. In highly corrosive environments grade 316 stainless steel is recommended and is available on request. Available in brushed finish on request, with lead times.

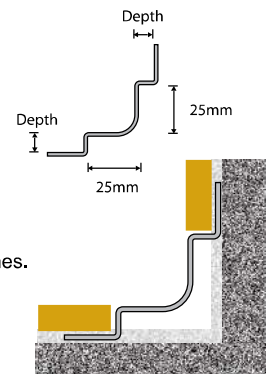

HEAVY DUTY STAINLESS STEEL TILE COVERS

These heavy duty Stainless Steel Trims are available in 2.5m lengths in grade 304 brushed unless otherwise specified.



STAINLESS STEEL TILE COVER

CODE	SIZE (w/thickness)	DESCRIPTION
STC400	40mm x 1.6mm	Stainless Steel Transition Cover
STC750	75mm x 1.6mm	Stainless Steel Transition Cover

The M-Trim Stainless Steel Cover is fitted between two surfaces of the same level. It is used to cover up the gaps created between tiles and different flooring. The Stainless Steel cover is screw fixed with plugs and stainless steel screws are recommended. In highly corrosive environments Grade 316 is recommended.

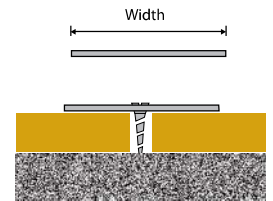

STAINLESS STEEL TILE COVER

CODE	SIZE (d/w/t)	DESCRIPTION
STRC050	30mm x 10mm x 5mm	Stainless Steel Transition Ramp Cover
STRC100	50mm x 20mm x 10mm	Stainless Steel Transition Ramp Cover
STRC150	50mm x 30mm x 15mm	Stainless Steel Transition Ramp Cover
STRC200	50mm x 40mm x 20mm	Stainless Steel Transition Ramp Cover

The M-Trim Stainless Steel Transition Ramp Cover is fitted between two surfaces of the different levels. It is used to cover up the gaps created between the tile levels and different flooring levels. The Stainless Steel cover is screw fixed with plugs, stainless steel screws are recommended. In highly corrosive environments Grade 316 is recommended. Available in different thicknesses for custom designed transitions.

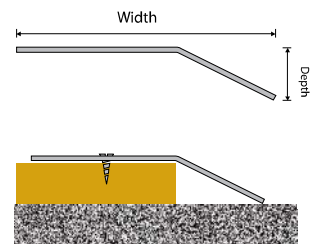

STAINLESS STEEL DÉCOR LISTELLO

CODE	SIZE (w)	DESCRIPTION
SDL490	49mm	Stainless Steel Décor Listello (5-6mm thick tile)
SDL740	74mm	Stainless Steel Décor Listello (5-6mm thick tile)

The M-Trim Stainless Steel Décor Listello is a profile that is screw fixed into the wall to receive tiles or mosaics for décor purposes. The channel is supplied in polished grade 430 stainless steel suitable for internal use. This profile can also be used as a dado rail in other areas of the home using tiles or mosaics in areas that are not commonly tiled. Other grades of stainless steel can be used in more corrosive areas and other sizes can be produced as required on special order with lead times. The Décor Listello is supplied in 2,5m lengths.

STAINLESS STEEL STAIR-NOSINGS

These Stainless Steel Stair Nosing profiles are available in 2.5m lengths in grade 430 polished finish. Other grades and finishes are available on special order with lead times.



STAINLESS STEEL TILE-IN STAIR-NOSING

CODE	SIZE (wxd)	DESCRIPTION
SDRTIN100	39mm x 10mm	Stainless Steel Diamond Rubber Tile-in Nosing (8-9mm tiles)
SDRTIN120	39mm x 12mm	Stainless Steel Diamond Rubber Tile-in Nosing (10x11mm tiles)

The M•Trim Stainless Steel Diamond Rubber Tile-in Nosing is suitable for internal use in medium foot traffic areas like offices and domestic applications. The cavity must be packed with adhesive for added strength. Grade 316 stainless steel can be used in coastal and corrosive environments. Brushed finish is also available on special order. The stainless steel stair nosing base and infill are sold separately.

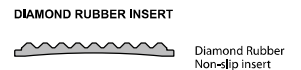
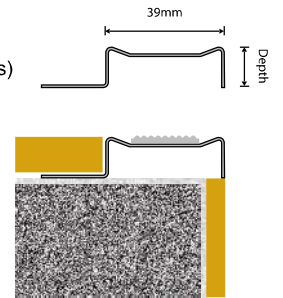

STAINLESS STEEL RETRO-FIT STAIR-NOSING

CODE	SIZE (wxd)	DESCRIPTION
SDRRN600	60mm x 30mm	Stainless Steel Diamond Rubber Retro-fit Stair-nosing for all stair types
SDRRN690	69mm x 30mm	Stainless Steel Diamond Rubber Retro-fit Stair-nosing for all stair types

The M•Trim Stainless Steel Diamond Rubber Retro-fit Stair Nosing is suitable for internal use in medium foot traffic areas like offices and domestic applications. The nosing can be screw and/or glue fixed. When screw fixing install the Diamond Rubber Insert last to hide the screw heads. Other grades and brushed finish are also available on special order. The stainless steel stair nosing base and infill are sold separately.

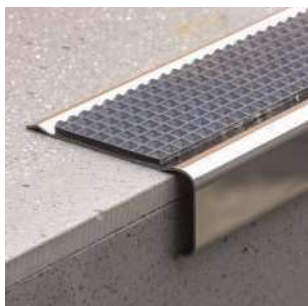
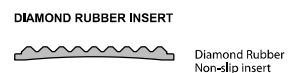
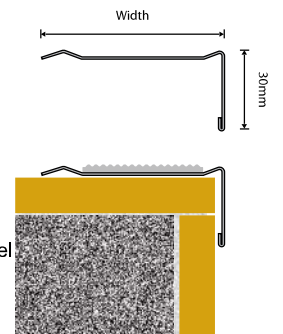

STAINLESS STEEL RETRO-FIT BULL-NOSING

CODE	SIZE (wxd)	DESCRIPTION
SDRRBN700,N	70mm x 30mm	Stainless Steel Diamond Rubber Retro-fit Bull-nosing for all stair types

The M•Trim Stainless Steel Diamond Rubber Retro-fit Bull-nosing is suitable for internal use in medium foot traffic areas like offices and domestic applications. The bull-nose gives a three dimensional design aesthetic. Other grades and surface finishes are available on special order. The stainless steel stair nosing base and infill are sold separately.

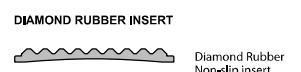
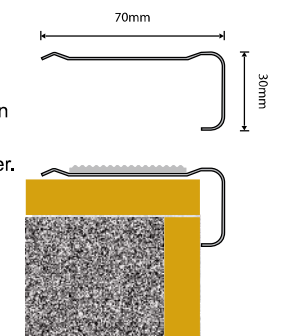

MOVEMENT & STRUCTURAL MOVEMENT JOINTS

All Movement Joints are available in 2.5m lengths and all Structural Movement Joints and Covers are available in 3m lengths unless otherwise specified.

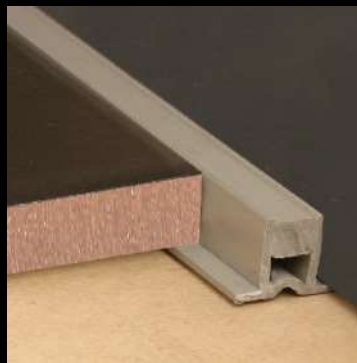
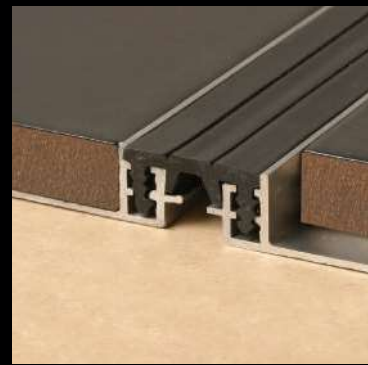

MTRIM POLYURETHANE MOVEMENT JOINTS INFILL COLOURS



GREY



BLACK



BEIGE

MTRIM PVC MOVEMENT JOINTS INFILL COLOURS



DOVE GREY



BLACK



PVC COMPRESSION JOINTS (PERIMETER JOINT)

CODE	SIZE (depth)	DESCRIPTION
PCJ080	8mm	PVC Compression Joint (6-7mm thick tile)
PCJ100	10mm	PVC Compression Joint (8-9mm thick tile)
PCJ120	12mm	PVC Compression Joint (10-11mm thick tile)

The M•Trim PVC Compression Joint is a low cost compression joint and is recommended as a perimeter joint. It is also an excellent alternative to using polysulphide/mastic joints, requiring no maintenance. The PVC is resistant to a range of chemicals, see technical specification sheet. The M•Trim PVC Movement Joints are available in a variety of depths and in the following standard colours: black and dove grey. Also available in other PVC colours as indicated on the colour chart, if order exceeds 500 lengths. The M•Trim PVC Compression joint absorbs 20% compression of the width of the joint.

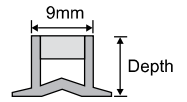

PVC MOVEMENT JOINTS

CODE	SIZE (depth)	DESCRIPTION
PMJ080	8mm	PVC Movement Joint (6-7mm thick tile)
PMJ100	10mm	PVC Movement Joint (8-9mm thick tile)
PMJ120	12mm	PVC Movement Joint (10-11mm thick tile)

The M•Trim PVC Movement Joint is ideal as a superior alternative to using polysulphide/mastic joints. The M•Trim PVC Movement Joint is a light to medium duty movement joint requiring no maintenance. Primarily used for pedestrian traffic, these PVC movement joints can be used in hotels, shops, offices and even large homes where a movement joint is required. The M•Trim PVC Movement Joints are available in a variety of depths and in the following standard colours: black and dove grey. Also available in other PVC colours as indicated on the colour chart, if order exceeds 500 lengths. The M•Trim PVC Movement joint absorbs 20% movement of the width of the joint.

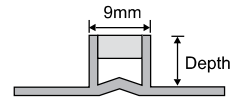

PVC SCREED JOINT

CODE	SIZE (d/t)	DESCRIPTION
PRSJ3508.G	35mm x 8mm	PVC Screed Joint

PVC screed joint is used as a Retro-fit for renovations and also new stone based surfaces such as clinker pavings, ceramic tiles and natural stone used as dividers. They are used to prevent tension due to pressure on flooring surface due to movement in the screed. They are available in grey only. On special request other depths are available as well as other colours. The profiles can be installed after paving or tiling has been completed as a Retro-fit. The PVC Screed Joint absorbs 20% compression of the width of the joint.

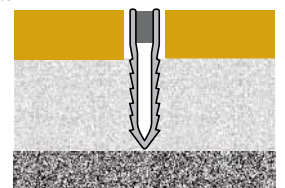
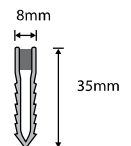

ALUMINIUM MOVEMENT JOINTS



CODE	SIZE (depth)	DESCRIPTION
AMJ030	3mm	Aluminium Movement Joint (2-3mm vinyl)
AMJ050	5mm	Aluminium Movement Joint (3-4mm thick tile)
AMJ060	6mm	Aluminium Movement Joint (4-5mm thick tile)
AMJ080	8mm	Aluminium Movement Joint (6-7mm thick tile)
AMJ100	10mm	Aluminium Movement Joint (8-9mm thick tile)
AMJ120	12mm	Aluminium Movement Joint (10-11mm thick tile)
AMJ150	15mm	Aluminium Movement Joint (13-14mm thick tile)
AMJ170	17mm	Aluminium Movement Joint (15-16mm thick tile)
AMJ225	22.5mm	Aluminium Movement Joint (20-22mm thick tile)

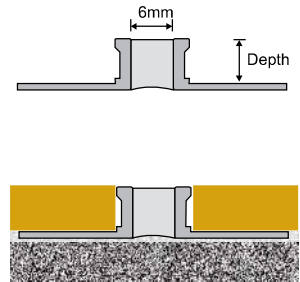

The M•Trim Aluminium Movement Joint is designed for heavy duty environments where a high volume of pedestrian and trolley traffic occurs such as airports, car show rooms, shopping and convention centres. The aluminium edge gives the tile edge excellent protection while the polyurethane infill provides the necessary movement needed and is highly resistant to weathering, chemicals and point loading. The polyurethane infill is available in black, grey and beige. For more information on the polyurethane infill see technical specification sheet. The M•Trim Aluminium Movement Joint is also available as a perimeter joint on request.

The M•Trim 3mm thick Aluminium movement joint is used as a movement joint for vinyls or very thin fast setting screeds. One flange of movement joint to be fixed to base screed before vinyl is glued down or screed is poured. The 6mm thick Aluminium movement joint can be used with 5mm thick wall tiles and 6mm thick quick drying screeds. The 17mm thick Aluminium movement joint is used with tiles. The M•Trim Aluminium movement joint absorbs 20% movement of the width of the movement joint.



BRASS MOVEMENT JOINTS

CODE	SIZE (depth)	DESCRIPTION
BMJ080	8mm	Brass Movement Joint (6-7mm thick tile) SOC
BMJ100	10mm	Brass Movement Joint (8-9mm thick tile)
BMJ120	12mm	Brass Movement Joint (10-11mm thick tile)
BMJ150	15mm	Brass Movement Joint (13-14mm thick tile) SOC
BMJ225	22.5mm	Brass Movement Joint (20-22mm thick tile) SOC

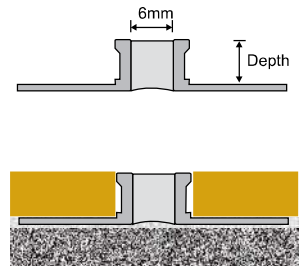

The M•Trim Brass Movement Joint is designed for heavy duty environments where a high volume of pedestrian and trolley traffic occurs such as airports, car show rooms, shopping and convention centres. The brass edge gives the tile edge excellent protection while the polyurethane infill provides the necessary movement needed and is highly resistant to weathering, chemicals and point loading. The polyurethane infill is available in black, grey and beige. For more information on the polyurethane infill see technical specification sheet. The M•Trim Brass Movement Joint is also available as a perimeter joint on request. M•Trim Brass movement joint absorbs 20% movement of the width of the movement joint.



STAINLESS STEEL MOVEMENT JOINTS

CODE	SIZE (depth)	DESCRIPTION
SMJ080	8mm	Stainless Steel Movement Joint (6-7mm thick tile)
SMJ100	10mm	Stainless Steel Movement Joint (8-9mm thick tile)
SMJ120	12mm	Stainless Steel Movement Joint (10-11mm thick tile)
SMJ150	15mm	Stainless Steel Movement Joint (13-14mm thick tile)
SMJ225	22.5mm	Stainless Steel Movement Joint (20-22mm thick tile)
SMJ250	25mm	Stainless Steel Movement Joint (23-25mm thick tile) SOC

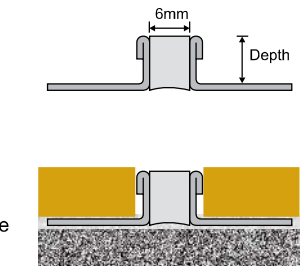

The M•Trim Stainless Steel Movement Joint is designed for heavy duty environments where a high volume of pedestrian and trolley traffic occurs such as airports, car show rooms, shopping and convention centres. The M•Trim stainless steel movement joint is suitable for dairies, wineries and all kitchens. The stainless steel edge gives the tile edge excellent protection while the polyurethane infill provides the necessary movement needed and is highly resistant to weathering, chemicals and point loading. The polyurethane infill is available in black, grey and beige. The M•Trim Stainless Steel movement joint absorbs 20% movement of the width of the movement joint. For more information on the polyurethane infill see technical specification sheet. The M•Trim Stainless Steel Movement Joint is also available as a perimeter joint on request. In highly corrosive environments grade 316 stainless steel is recommended and is available on request.

CONTRACTORS ALUMINIUM MOVEMENT JOINTS

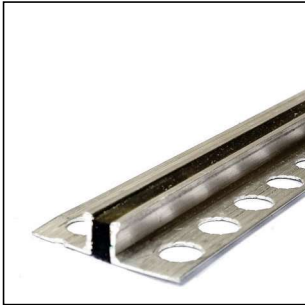
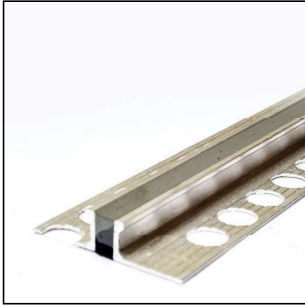

CODE	SIZE (depth)	DESCRIPTION
CAMJ100	10mm	Aluminium Movement Joint (8-9mm thick tile)
CAMJ120	12mm	Aluminium Movement Joint (10-11mm thick tile)

The CAMJ movement joints are light duty/budget movement joints for domestic and light commercial applications. The sightline is 11mm due to the thinner aluminium straight edges being used. These movement joints are installed in the same way as the AMJ versions.

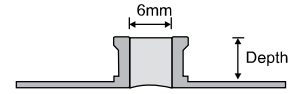

AMJ is suitable for shopping centers, offices and other high volume pedestrian and trolley traffic.

BMJ is suitable for very heavy traffic like airports, car showrooms and industrial applications.

SMJ is suitable for high volumes of foot and trolley traffic in hygienic areas like hospitals, clinics, wineries, dairies and food preparation areas like kitchens.



Scan the QR code below to write an *MTRIM* Spec



1. PRODUCT SEARCH
2. SELECT SPEC
3. EMAIL SPEC



Scan the QR code below to write an *KIRK STRUCTURAL* Spec



1. PRODUCT SEARCH
2. SELECT SPEC
3. EMAIL SPEC



3m Lengths



ALUMINIUM STRUCTURAL SCREED JOINT

CODE	SIZE (depth)	DESCRIPTION
ASSJ390R	39mm	Aluminium Structural Screed Joint (With Ridged Infill)
ASSJ390H	39mm	Aluminium Structural Screed Joint (With Hospital Infill)

The M•Trim Aluminium Structural Screed Joint is used for screeds, tiled floors, vinyl floors, stone slabs and asphalt surfaces. The flexible PVC infill is made from high quality flexible PVC. Colours available are black and dark grey.

The joints are capable of absorbing movement in two directions. The infill is weather resistant and resistant to certain chemicals. Joint widths vary between 10-30mm. Total movement is 10mm (plus 5mm - minus 5mm). More technical information and fitting instructions are available on request. Legs and infill sold separately.

H – The M•Trim hospital insert is smooth and does not have the V notches on the surface, like the standard flexible PVC insert. The hospital insert is easy to clean and does not collect dirt, used in hospitals, food processing areas, and areas where hygiene is critical.

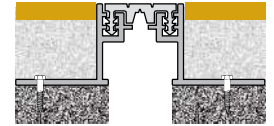
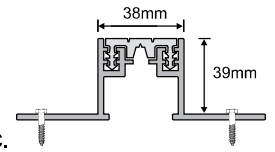

ALUMINIUM STRUCTURAL MOVEMENT JOINT

CODE	SIZE (depth)	DESCRIPTION
ASSJ130R	13mm	Aluminium Structural Movement Joint (with Standard Infill)
ASSJ130H	13mm	Aluminium Structural Movement Joint (with Hospital Infill)
ASSJ170R	17mm	Aluminium Structural Movement Joint (with Standard Infill)
ASSJ170H	17mm	Aluminium Structural Movement Joint (with Hospital Infill)

The M•Trim Structural Movement Joint for depths of 13mm and 17mm are used for powerfloated slabs, where screeds are not used to lay tiles and tiles are laid directly on top of powerslabs. The 13mm is for 10mm to 12mm tiles and the 17mm is for 13mm to 16mm tiles.

The M•Trim Structural Movement Joint is screw fixed on both sides of the joint using screws and plugs. Use 25mm pieces of infill as spacers to ensure correct width while screw fixing and tiling. Remove spacers when you are ready to fit the infill. Follow fitting instructions to avoid stretching the infill.

The joints are capable of absorbing movement in two directions. The infill is weather resistant and resistant to certain chemicals. Joint widths vary between 10-30mm. Total movement is 10mm (plus 5mm - minus 5mm). More technical information and fitting instructions are available on request. Legs and infill sold separately.

H – The M•Trim hospital insert is smooth and does not have the V notches on the surface, like the standard flexible PVC insert. The hospital insert is easy to clean and does not collect dirt, used in hospitals, food processing areas, and areas where hygiene is critical.

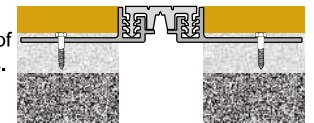
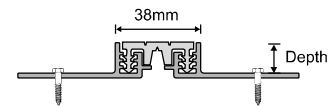

ALUMINIUM RETRO-FIT STRUCTURAL JOINT

CODE	SIZE (depth)	DESCRIPTION
ASRJ150R	15mm	Aluminium Retro-fit Structural Joint (with Standard Infill)
ASRJ150H	15mm	Aluminium Retro-fit Structural Joint (with Hospital Infill)

The M•Trim Retro-fit Structural Movement Joint is used in refurbishments, when the floor has already been laid and needs a structural joint to take movement. The flanges get screw fixed on both sides of the joint and affixed with the appropriate adhesives to the floor material. The flexible PVC infill is made from high quality flexible PVC. Colours of infill are black and dark grey.

The joints are capable of absorbing movement in two directions. The infill is weather resistant and resistant to certain chemicals. Minimum joint width is 40mm. Total movement is 10mm (plus 5mm – minus 5mm) Smooth Hospital insert is also available. Legs and infill sold separately.

H – The M•Trim hospital insert is smooth and does not have the V notches on the surface, like the standard flexible PVC insert. The hospital insert is easy to clean and does not collect dirt, used in hospitals, food processing areas, and areas where hygiene is critical.

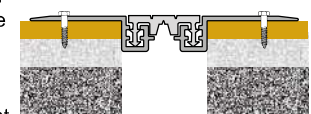
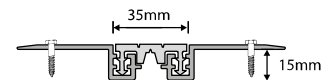

STRUCTURAL MOVEMENT JOINT COVERS

All Structural Movement Joints and Covers are available in 3m lengths unless otherwise specified.

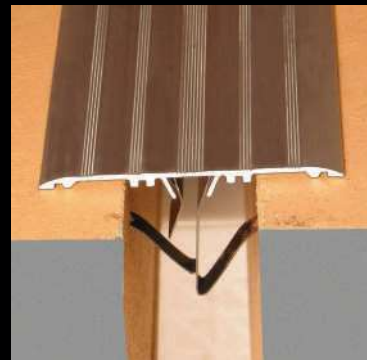
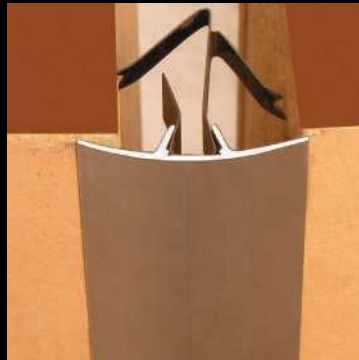

3m Lengths

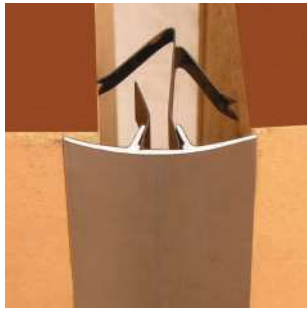

ALUMINIUM STRUCTURAL WALL JOINT COVER

CODE	SIZE (width)	DESCRIPTION
ASCW480	48mm	Aluminium Structural Wall Joint Cover

The M•Trim Aluminium Structural Wall Joint Cover is designed for secondary covering of wall, dry wall, ceiling and facade movement joints, with great joint tolerances. Joint width varies between 15-35mm. Used for internal/external walls and ceilings. Quick and easy installation is achieved by surface fixing the profiles which are anchored permanently in the joint using spring steel clips. Use five steel spring clips per 3m length. Available in matt silver or any of the anodised colours on request.

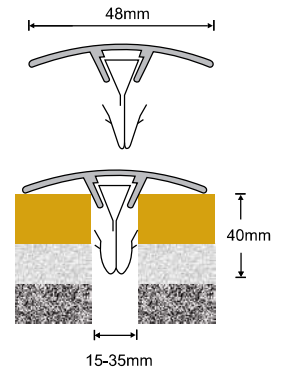

ALUMINIUM STRUCTURAL WALL CORNER JOINT COVER

CODE	SIZE (width)	DESCRIPTION
ASCCW396	39mm	Aluminium Structural Wall Corner Joint Cover

The M•Trim Structural Wall Corner Joint Cover is used as a secondary covering of movement joints on irregular and uneven walls, dry walls, ceilings or facades. The joint tolerance is 15mm to 35mm. It is used between ceilings and walls, and wall corners. Quick and easy installation is achieved by surface fixing the profiles which are anchored permanently in the joint using spring steel clips. Use five steel spring clips per 3m length. Available in matt silver or any of the anodised colours on request.

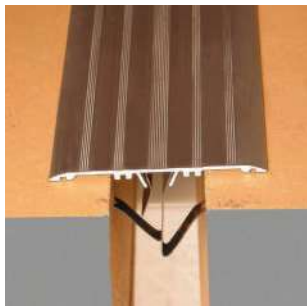
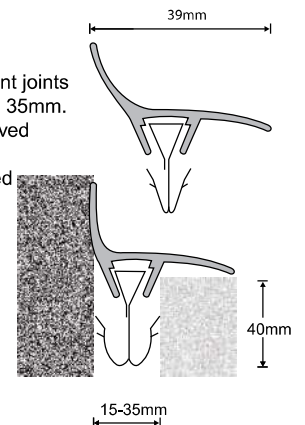

ALUMINIUM STRUCTURAL FLOOR JOINT COVER

CODE	SIZE (depth)	DESCRIPTION
ASCF760	76mm	Aluminium Structural Floor Joint Cover

The M•Trim Aluminium Structural Floor Joint Cover is suitable for interior and exterior use. Medium duty covers are suitable for shopping centres, high pedestrian traffic areas and airports. On request, Butyl rubber strips can be added to either side of the cover. The joint tolerance is between 15-35mm. Quick and easy installation is achieved by surface fixing the profiles which are anchored permanently in the joint using steel spring clips. Use five spring steel clips per 3m length. This joint cover can also be screw fixed. Available in matt silver or any of the anodised colours on request.

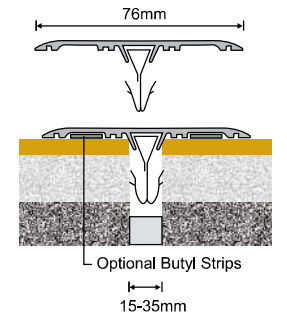

ALUMINIUM STRUCTURAL FLOOR JOINT COVER

CODE	SIZE (width)	DESCRIPTION
ASCF760 (NF)	76mm	Aluminium Structural Floor Joint Cover with no flange

The M•Trim Structural Floor Cover of 76mm width with no flanges is used over an existing joint that is already filled with foam or joint filler and there is no place to fit the S Clips. The cover is screw fixed on one side only and strips of butyl tape are adhered to the cover and floor surface ensuring reduction in sound on traffic over the cover as well as an effective seal and adhesion of the cover to the flooring material. When using Butyl tape, ensure the aluminium cover and the floor surface are thoroughly cleaned before applying it. Available in 3m lengths and in matt silver. On request you can ask for any of the anodised colours on the colour chart.

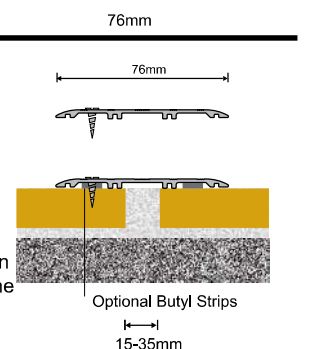



ALUMINIUM STRUCTURAL FLOOR JOINT COVER

CODE	SIZE (width)	DESCRIPTION
ASCF106	106mm	Aluminium Structural Floor Joint Cover

The M-Trim Aluminium Structural Floor Joint Cover is suitable for interior and exterior use. Heavy duty covers are available for factories and warehouses and are suitable for heavy pedestrian and trolley traffic. On request, Butyl rubber strips can be added to either side of the cover. The joint tolerance is between 15-40mm. Quick and easy installation is achieved by surface fixing the profiles which are anchored permanently in the joint using steel spring clips. Use five steel spring clips per 3m length. This joint can also be screw fixed. Available in matt silver or any of the anodised colours on request.

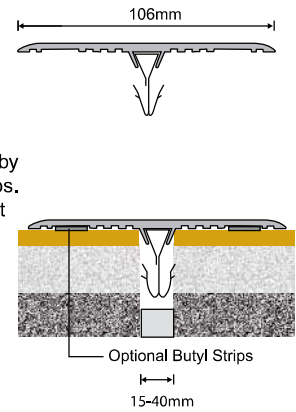

ALUMINIUM STRUCTURAL FLOOR JOINT COVER

CODE	SIZE (width)	DESCRIPTION
ASCF106 (NF)	106mm	Aluminium Structural Floor Joint Cover with no flange

The M-Trim Structural Floor Joint Cover of 106mm width with no flanges is used over an existing joint that is already filled with foam or joint filler and there is no place to fit the SClips. The cover is screw fixed on one side only and strips of butyl tape are adhered to the cover and floor surface ensuring reduction in sound on traffic over the cover as well as an effective seal and adhesion of the cover to the flooring material. When using Butyl tape, ensure the aluminium cover and the floor surface are thoroughly cleaned before applying it. Available in 3m lengths and in matt silver. On request you can ask for any of the anodised colours on the colour chart.

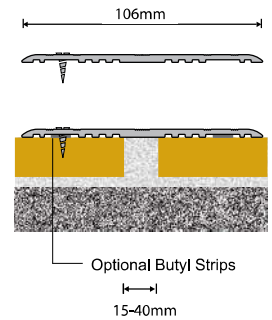

ALUMINIUM STRUCTURAL COVER CLIPS AND BUTYL TAPE

CODE	SIZE (width)	DESCRIPTION
SCLIP		Pack of 5 Aluminium Structural Cover Clip
BUTYL	6m (Double Sided)	BUTYL Tape

The SClip is a clip manufactured from Spring Steel and is used in joints of from 15mm to 35mm in width. The Spring Steel is treated against corrosion by passivation of the spring steel. Use 5 SClips for every 3m length of cover on floors and only sold in packs of 5.

The strips of butyl tape are adhered to the cover and floor surface ensuring reduction in sound on traffic over the cover as well as an effective seal and adhesion of the cover to the flooring material. When using Butyl tape, ensure the aluminium cover and the floor surface are thoroughly cleaned before applying it. Available in 6m lengths and 15m lengths. Butyl tape adds resistance to water ingress on floor joints.



PVC TRIMS

All PVC Trims are available in 2.5m lengths unless otherwise specified.



MTRIM PVC COLOURS



Please note that the colour representation in this catalogue is an approximation and is as close as the printing process will allow. Kirk Marketing does not in any way guarantee that the colours in this catalogue are an exact match to the finished product. Kirk Marketing reserves the right in its absolute discretion to vary any specification or design, and to supply products which are in our sole opinion, equivalent to those being offered to the purchaser.



PVC ECONO ROUND EDGE TRIM

CODE	SIZE (Depth)	DESCRIPTION
PEE070	7mm	PVC Econo Round Edge Trim (5-6mm thick tiles)
PEE090	9mm	PVC Econo Round Edge Trim (8-9mm thick tiles)
PEE125	12.5mm	PVC Econo Round Edge Trim (10-11mm thick tile)

The M•Trim PVC Econo Round Edge Trim is an economy edge trim for use on wall corners to protect the edge of the tile from light impact. This is an open profile for budget applications and domestic use where a simple solution is required to finish off an external corner with a low amount of edge protection. The PVC Econo Round Edge Trim is offered in a limited colour range in 2,5m lengths.

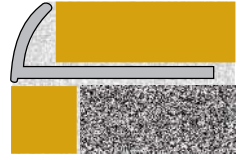
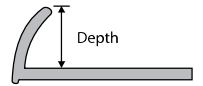

PVC ROUND EDGE TRIM

CODE	SIZE (Depth)	DESCRIPTION
PRE070	7mm	PVC Round Edge Trim (5-6mm thick tile)
PRE090	9mm	PVC Round Edge Trim (7-8mm thick tile)
PRE105	10.5mm	PVC Round Edge Trim (9-10mm thick tile)
PRE125	12.5mm	PVC Round Edge Trim (11-12mm thick tile)

The M•Trim Round Edge Trim features a quadrant face designed to protect from impact, the edges of wall tiles on external corners. PVC Round Edge Trims give corners a straight and perfectly rounded decorative finish, and are good for 3 dimensional alignment. The Round Edge Trims speed up installation by eliminating time consuming mitring and improve the tile finish by covering sharp edges. M•Trim has a popular range of trim depths. Available in all the PVC colours as indicated on the colour chart.

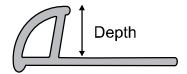

PVC CONCAVE EDGE TRIM

CODE	SIZE (Depth)	DESCRIPTION
PCE070	7mm	PVC Concave Edge Trim (5-6mm thick tile)
PCE090	9mm	PVC Concave Edge Trim (7-8mm thick tile)

The M•Trim Concave Edge Trim can be used to cover uneven edges between tiled wall and floor corners or between wall and wall internal corners or between tiled wall and kitchen/ bathroom surfaces (horizontal surfaces). When used in conjunction with silicone the concave edge trim seals the surface, provided there is no movement experienced. The silicone is placed on the inside of the trim between the tile and trim and between the underside of the concave trim and the surface that it rests on. The PVC Concave Edge Trim is available in White and some PVC colours on the colour chart. Non-Stock colours are available with a minimum order quantity of 500 lengths.

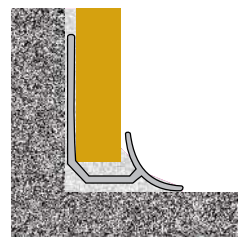
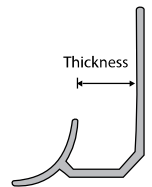

PVC BATH SEAL

CODE	SIZE (w/d)	DESCRIPTION
PBS010	10mm x 10mm	PVC Bath Seal
PBS020	20mm x 20mm	PVC Bath Seal

An economical PVC seal used to seal the gap between a wall and basin or counter top. The PVC Bath Seal is self-adhesive. Make sure that the two adjacent surfaces are degreased and clean, use M-Clean Multi-purpose Cleaner for this purpose. The PVC Bath Seal is only available in white and is packaged in 3,5m lengths.

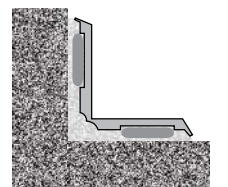
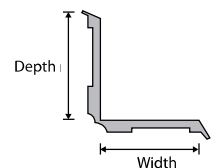

PVC RETRO-FIT BENDABLE BEADING



CODE	SIZE (w)	DESCRIPTION
PBB150.01	15mm	PVC Bendable Beading 15mm White 3500mm roll

PVC Bendable Beading for use in kitchens and bathrooms to cover gaps in internal corners. Not suitable for use in a shower. Butyl adhesive and smooth plastic cover.

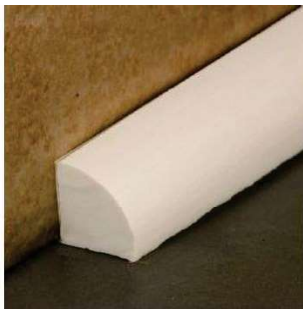
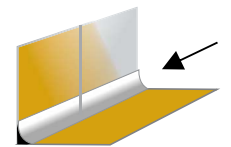
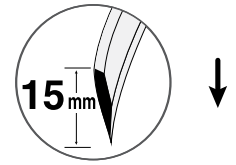

PVC BENDABLE BEADING

CODE	SIZE (w/d)	DESCRIPTION
PBB070.01	7mm x 7mm	PVC Bendable Beading 7mm White 3500mm roll
PBB090.01	9mm x 9mm	PVC Bendable Beading 9mm White 3500mm roll

PVC Bendable Beading 7x7mm White. Used to cover gaps between wall tiles and counters and similar areas. Glue down with silicone or similar adhesive.

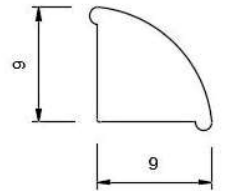

PVC WALL CORNER PROTECTOR (Available Black or White)

CODE	SIZE (w/d)	DESCRIPTION
PCP150	15mm x 15mm	PVC Wall Corner Protector
PCP250	25mm x 25mm	PVC Wall Corner Protector
PCP400	40mm x 40mm	PVC Wall Corner Protector

The M•Trim Wall Corner Protector is retrospectively fixed using silicone adhesives. It is used to provide protection on external corners after the main wall covering or finish has been installed. Especially useful in renovations where damage has already occurred, and the corner protector is then used to cover the damage, at minimal cost.

The M•Trim Wall Corner Protector provides an aesthetically pleasing alternative to major renovations.

Other PVC colours from the M•Trim colour chart can be manufactured for a minimum order of 500 lengths. Aluminium, stainless steel and brass corner protectors are also available, please see appropriate categories in the catalogue. Available in black or white.

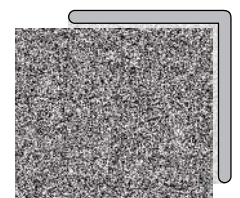
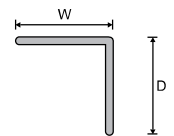

PVC RETRO-FIT STAIR-NOSING

CODE	SIZE (w/d)	DESCRIPTION
PRN450	45mm x 30mm	PVC Retro-fit Stair-nosing

The M•Trim PVC Retro-fit Stair-nosing is an economical Retro-fit PVC stair-nosing used on vinyl, wood, screed and tiled stairs internally. This profile is not suitable for external use.

Applied using a PVC contact adhesive or silicone adhesive. Available in a few selected colours: brown, black and dark grey. Other colours from the M•Trim colour chart can be ordered for a minimum quantity of 500 lengths.

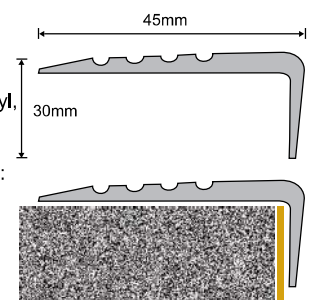



ALUMINIUM & PVC SECTIONS

ALUMINIUM SECTIONS Supplied in 2,5m lengths

Aluminium Sections are standard profiles used by the DIY enthusiast as well as contractors and shop-fitters. The range includes aluminium sections used with glass and wooden panels and boards. There are also various other profiles that serve varying purposes on building sites. In the expanded definition Aluminium Sections would include flat bars and equal angles and all these profiles can be found together on the K068 Aluminum Section Stand in hardware stores and some tile shops.

PLEASE NOTE: highlighted only available through tile retailers & hardware stores.

PROFILE CHART

U CHANNEL



AUC191712-250.N



19.2mm x 16.8mm
1.2mm thick

AUC956316-250.N



9.5mm x 6.3mm
1.6mm thick

Description

Aluminium U-Channel used to cap the edge of sheet board and other general shopfitting requirements. Natural mill finish

T PIECE



ATP252516-250.N

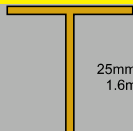

25mm x 25mm
1.6mm thick

Description

Aluminium T-Piece used for various shopfitting purposes. Can also be used with thick floor and wall finishes. Natural mill finish.

PVC EQUAL ANGLE / CORNER PROTECTOR



PCP400.01/08

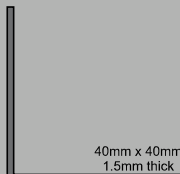

40mm x 40mm
1.5mm thick

PCP250.01/08



25mm x 25mm
1mm thick

PCP150.01/08

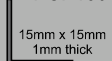

15mm x 15mm
1mm thick

Description

PVC Corner Protector for light duty protection of wall corners. Apply using a suitable adhesive. White and Black colours available.

FLAT BAR



AFB502-250.N

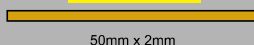

50mm x 2mm

AFB252-250.N



25mm x 2mm

AFB193-250.N



19mm x 3mm

AFB192-250.N



19mm x 2mm

Description

Aluminium Flat Bar used as a water-stop, inlay or decorative strip. Natural mill finish

Many other sizes are available on special order with a minimum order quantity.







ALUMINIUM & PVC SECTIONS





ALUMINIUM SECTIONS Supplied in 2,5m lengths

Aluminium Sections are standard profiles used by the DIY enthusiast as well as contractors and shop-fitters. The range includes aluminium sections used with glass and wooden panels and boards. There are also various other profiles that serve varying purposes on building sites. In the expanded definition Aluminium Sections would include flat bars and equal angles and all these profiles can be found together on the K068 Aluminum Section Stand in hardware stores and some tile shops.

PLEASE NOTE: highlighted only available through tile retailers & hardware stores.

PROFILE CHART

ROUND TUBE	
STRAIGHT EDGE	
BOARD CORNER	
EQUAL ANGLE / CORNER PROTECTOR	

<p>ART9512-250.N</p>  <p>9,5mm x 9,5mm 1,2mm thick</p>	<p>Description Aluminium Round tube for general DIY use. Natural mill finish.</p>
<p>ABSE75XX.LD</p>  <p>75mm x 18mm 1,7mm thick</p> <p>ABSE66XX.MD</p>  <p>66mm x 18,5mm 1,6mm thick</p>	<p>Description Light Duty Builders Straight Edge used when plastering walls. The profile is used to cut and level plaster on walls. Available in various lengths</p> <p>Description Medium Duty Builders Straight Edge is used when plastering walls or levelling floor screeds. The profile has grooves for grip and is available in many lengths.</p>
<p>ABC16612-250.N</p>  <p>28,5mm x 18,9mm 1,2mm thick</p>	<p>Description Aluminium Board Corner for 16mm boards. Provides a neat corner in shopfitting. Natural mill finish.</p>
<p>12mm x 12mm 1,5mm thick</p> <p>ACP121215-250.N</p> <p>15mm x 15mm 1,5mm thick</p> <p>ACP151515-250.N</p> <p>19mm x 19mm 1,6mm thick</p> <p>ACP191916-250.N</p> <p>25mm x 25mm 1,5mm thick</p> <p>ACP252515-250.N</p> <p>25mm x 25mm 3mm thick</p> <p>ACP25253-250.N</p> <p>32mm x 32mm 1,6mm thick</p> <p>ACP323216-250.N</p> <p>38mm x 38mm 2mm thick</p> <p>ACP380-250.N</p>	<p>Description Aluminium equal angle used to protect corners when installing wall and floor coverings in tiling, shop-fitting and general DIY. Natural mill finish. 3m length.</p>



K019
1000mm Freestanding MTrim stand



K025
600mm Freestanding MTrim stand



K068
600mm Freestanding MTrim stand
Sections trim stand



K075
1000mm Freestanding Contractors Trim Stand



K025
600mm Freestanding Mtrim Decor stand



K084
600mm Freestanding MTrim Threshold trim stand



K030
DL Flyer Stand



K032
A4 Flyer Stand



K071
500x500mm Kirk Décor MTrim Tower



K072
Kirk Décor MTrim Counter Top Unit

PVC - Rigid

Tensile Strength	Elastic Modulus	%Elongation at break	Flexural Strength	Flexural Modulus	Izod Impact Resistance (ASTM)	Izod Impact Resistance (ISO)
24,82MPa	1187MPa	27,445MPa	39,15MPa	1381MPa	74,811J/m	9,01439J/m

PVC - Flexible

Shore A Hardness (ASTM D2240)	Tensile Strength (ASTM D638)	% Elongation of Break	Modulus	Maximum Tear Resistance	Brittleness Temp	Brittleness Onset Temp	
G6	73	6,439MPa	254,6%	5,75	22.33N/mm	-27,5°C	-5,47°C

ALUMINIUM

Grade 6063, T5 Temper, in compliance with BS1474: 1987 Standard Specifications.

							Others		
Silicon	Iron	Copper	Manganese	Chromium	Zinc	Titanium	Each	Total	Aluminium
Si%	Fe%	Cu%	Mg%	Cr%	Zn%	Ti%	%	%	Al%
0.2 - 0.6	0.35	0.10	0.45 - 0.9	0.10	0.10	0.10	0.05	0.15	rem

ALUMINIUM ANODIZING: 15 MICRON THICK, CHEMICALLY ANODISED Used colours are all anodised to between 10 to 15 micron thick on aluminium. Anodised surfaces are sensitive to alkaline building materials, such as tile grout. If grout is allowed to come into contact with an anodised surface for an extended period of time the coating will be irreparably damaged. Either remove grout immediately with sponge and water or protect anodised surface before fitting using masking tape.

BRASS CuZn44Pb2 (EN 12167)

Copper	Lead	Tin	Iron	Nickel	Aluminium	Zinc
Cu%	Pb%	Sn%	Fe%	Ni%	Al%	Zn%
54 - 55	1.3 - 2	0.2 max	0.4 max	0.2 max	0.6	rem

BRASS CuZn30 DIN EN 1652

Copper	Lead	Tin	Iron	Nickel	Aluminium	Zinc	Impurities
Cu%	Pb%	Sn%	Fe%	Ni%	Al%	Zn%	
69 - 71	0.05 max	0.1 max	0.05 max	0.3 max	0.02 max	max rem	0.1

STAINLESS STEEL - Grade 430 (ASTM A240)

Analysis	C%	Mn%	P%	S%	Si%	Cr%	Ni%	Fe%
ASTM A240	0.1 max	1.0 max	0.045 max	0.030 max	1.0 max	16.0 -18.0	8.0 max	rem
Typical	0.05	0.7	0.021	0.024	0.6	17.0	0.58	rem

STAINLESS STEEL - Grade 304 (ASTM A240)

Analysis	C%	Mn%	P%	S%	Si%	Cr%	Ni%
ASTM A240	0.08 max	2.0 max	0.045 max	0.030 max	1.0 max	18.0 to 20.0	8.0 to 10.50
Typical	0.03	-	-	-	-	-	8.0 - 12.0

STAINLESS STEEL - Grade 316 (ASTM A240)

Analysis	Carbon	Manganese	Phosphorus	Sulphur	Silicon	Chromium	Nickel	Nitrogen	Molybdenum
ASTM A240	C%	Mn%	P%	S%	Si%	Cr%	Ni%	N%	Mo%
	0.08 max	2 max	0.045 max	0.030 max	0.75 max	16.0 -18.0	10.0 - 14.0	10.0 max	2.0 -3.0

POLYURETHANE INFILL USED IN METAL MOVEMENT JOINTS The polyurethane used is manufactured by an ISO9002 company. The polyurethane elastomer produced has excellent hydrolysis, good abrasion, chemical resistance, and physical properties. Shore hardness is at a maximum of 42 Shore A. The M•Trim polyurethane movement joint meets the British Standard BS5385 that recommends a joint is able to absorb 20% of the width of the joint in movement accommodation. More technical information is available on request. PVC Movement Joint infill: Elongation at break is 236.5%, after 1000 hours of aging elongation at break is 213,3%. Shore A Hardness is 63. This flexible compound gives a smooth satin surface finish, suitable to take 20% movement.



FLOOR & WALL FINISHING TRIMS



STRUCTURAL MOVEMENT JOINTS



FLOOR & WALL DECORATIVE PRODUCTS



MATting SOLUTIONS



TILING TOOLS



MOSAICS



LAMINATE VINYL & LVT FLOORING



FLOOR & WALL SKIRTING



CLEANING CHEMICALS

PLEASE NOTE: Items highlighted are only available through tile retailers & hardware stores.

20+ **KIRK** YEARS
marketing

10 BRANDS

FLOOR AND WALL
FINAL SOLUTIONS
SINCE 2002



COMMMITTED TO
CLASS LEADING
EXCELLENCE



FLOOR AND WALL
FINAL SOLUTIONS



Call Kirk today to arrange for one of our service driven sales representatives to present samples at your convenience.

JOHANNESBURG: 011 444 1441

ADDRESS: 31c Lake Road, Longmeadow Business Estate, Edenvale, Gauteng, 1609

CAPE TOWN: 021 949 2226

ADDRESS: Unit 5 & 6, Atom Park, Neutron Road, Bellville Triangle, Cape Town, 7530

DURBAN: 031 564 1175

ADDRESS: Unit 16, Old Mill Industrial Park, 15 Sucrose Crescent, Mount Edgecombe, Durban

PE: 086 054 7573

ADDRESS: 119 a Albert Road Walmer , Port Elizabeth

info@kirk.co.za | www.kirk.co.za